

# Operator's Manual

Lycoming

## TIO-540 Series

### Parallel Valve Cylinder

### Heads

Approved by FAA

4<sup>th</sup> Edition

Part No. 60297-23P

---

**LYCOMING**

652 Oliver Street  
Williamsport, PA. 17701 U.S.A.  
570/323-6181

March 2006

## **TIO-540 Series Parallel Valve Cylinder Heads Operator's Manual**

Lycoming Part Number: 60297-23P

©2006 by Lycoming. All rights reserved.

Lycoming and "Powered by Lycoming" are trademarks or registered trademarks of Lycoming.

All brand and product names referenced in this publication are trademarks or registered trademarks of their respective companies.

### **For additional information:**

#### **Mailing address:**

Lycoming Engines  
652 Oliver Street  
Williamsport, PA 17701 U.S.A.

#### **Phone:**

Factory: 570-323-6181  
Sales Department: 570-327-7268  
Fax: 570-327-7101

Lycoming's regular business hours are Monday through Friday from 8:00 AM through 5:00 PM Eastern Time (+5 GMT)

**Visit us on the World Wide Web at:**

<http://www.lycoming.com>

# **LYCOMING**

## **OPERATOR'S MANUAL REVISION**

<b>REVISION NO.</b>	<b>PUBLICATION</b>	<b>PUBLICATION NO.</b>	<b>PUBLICATION DATE</b>
60297-23P-2	TIO-540 SERIES PARALLEL VALVE CYLINDER HEADS	60297-23P	March 2006
The page(s) in this revision replace, add to, or delete current pages in the operator's manual.			
<b>PREVIOUS REVISION</b>		<b>CURRENT REVISION</b>	
<b>August 2006</b>  3-3, 3-4		<b>October 2006</b>  2-3, 5-1	



# LYCOMING OPERATOR'S MANUAL

## ATTENTION

### **OWNERS, OPERATORS, AND MAINTENANCE PERSONNEL**

This operator's manual contains a description of the engine, its specifications, and detailed information on how to operate and maintain it. Such maintenance procedures that may be required in conjunction with periodic inspections are also included. This manual is intended for use by owners, pilots and maintenance personnel responsible for care of Lycoming powered aircraft. Modifications and repair procedures are contained in Lycoming overhaul manuals; maintenance personnel should refer to these for such procedures.

### *SAFETY WARNING*

*NEGLECTING TO FOLLOW THE OPERATING INSTRUCTIONS AND TO CARRY OUT PERIODIC MAINTENANCE PROCEDURES CAN RESULT IN POOR ENGINE PERFORMANCE AND POWER LOSS. ALSO, IF POWER AND SPEED LIMITATIONS SPECIFIED IN THIS MANUAL ARE EXCEEDED, FOR ANY REASON; DAMAGE TO THE ENGINE AND PERSONAL INJURY CAN HAPPEN. CONSULT YOUR LOCAL FAA APPROVED MAINTENANCE FACILITY.*

### SERVICE BULLETINS, INSTRUCTIONS, AND LETTERS

Although the information contained in this manual is up-to-date at time of publication, users are urged to keep abreast of later information through Lycoming Service Bulletins, Instructions and Service Letters which are available from all Lycoming distributors or from the factory by subscription. Consult the latest revision of Service Letter No. L114 for subscription information.

### *SPECIAL NOTE*

*The illustrations, pictures and drawings shown in this publication are typical of the subject matter they portray; in no instances are they to be interpreted as examples of any specific engine, equipment or part thereof.*

# **LYCOMING OPERATOR'S MANUAL**

## **IMPORTANT SAFETY NOTICE**

Proper service and repair is essential to increase the safe, reliable operation of all aircraft engines. The service procedures recommended by Lycoming are effective methods for performing service operations. Some of these service operations require the use of tools specially designed to the task. These special tools must be used when and as recommended.

It is important to note that most Lycoming publications contain various Warnings and Cautions which must be carefully read in order to minimize the risk of personal injury or the use of improper service methods that may damage the engine or render it unsafe.

It is also important to understand that these Warnings and Cautions are not all inclusive. Lycoming could not possibly know, evaluate or advise the service trade of all conceivable ways in which service might be done or of the possible hazardous consequences that may be involved. Accordingly, anyone who uses a service procedure must first satisfy themselves thoroughly that neither their safety nor aircraft safety will be jeopardized by the service procedure they select.

# LYCOMING OPERATOR'S MANUAL

## TABLE OF CONTENTS

		PAGE
SECTION 1	DESCRIPTION	1-1
SECTION 2	SPECIFICATIONS	2-1
SECTION 3	OPERATING INSTRUCTIONS	3-1
SECTION 4	PERIODIC INSPECTIONS	4-1
SECTION 5	MAINTENANCE PROCEDURES	5-1
SECTION 6	TROUBLE-SHOOTING	6-1
SECTION 7	INSTALLATION AND STORAGE	7-1
SECTION 8	TABLES	8-1

**This Page Intentionally Left Blank**



# LYCOMING OPERATOR'S MANUAL

## SECTION 1 DESCRIPTION

	Page
General.....	1-1
Cylinders.....	1-1
Valve Operating Mechanism .....	1-1
Crankcase .....	1-1
Connecting Rods .....	1-1
Pistons .....	1-1
Accessory Housing .....	1-1
Oil Sump and Induction Assembly.....	1-2
Cooling System.....	1-2
Induction System.....	1-2
Turbocharger System .....	1-2

**This Page Intentionally Left Blank**

**SECTION 1**

**DESCRIPTION**

The TIO-540 series listed in this manual are six cylinder, direct drive, horizontally opposed, fuel injected, turbocharged, air cooled engines with parallel head valves.

In referring to the location of the various engine components, the parts are described in their relationship to the engine as installed in the airframe. Thus, the power take-off end is considered the front and the accessory drive end the rear. The sump section is considered the bottom and the opposite side of the engine where the shroud tubes are located the top. Reference to the left and right side is made with the observer facing the rear of the engine. The cylinders are numbered from front to rear, odd numbers on the right, even numbers on the left. The direction of rotation for accessory drives is determined with the observer facing the drive pad.

*Cylinders* – The cylinders are of conventional air cooled construction with the two major parts, head and barrel, screwed and shrunk together. The heads are made from an aluminum alloy casting with a fully machined combustion chamber. Rocker shaft bearing supports are cast integral with the head along with housings to form the rocker boxes for both valve rockers. The cylinder barrels, which are machined from chrome nickel molybdenum steel forgings, have deep integral cooling fins and the inside of the barrels are ground and honed to a specified finish.

*Valve Operating Mechanism* – A conventional type camshaft is located above and parallel to the crankshaft. The camshaft actuates hydraulic tappets which operate the valves through push rods and valve rockers. The valve rockers are supported on full floating steel shafts. The valve springs bear against hardened steel seats and are retained on the valve stems by means of split keys.

*Crankcase* – The crankcase assembly consists of two reinforced aluminum alloy castings, fastened together by means of studs, bolts and nuts. The mating surfaces of the two castings are joined without the use of a gasket, and the main bearing bores are machined for use of precision type main bearing inserts.

*Crankshaft* – The crankshaft is made from a chrome nickel molybdenum steel forging. All bearing journal surfaces are nitrided. Freedom from torsional vibration is assured by a system of pendulum type dynamic counterweights.

*Connecting Rods* – The connecting rods are made in the form of “H” sections from alloy steel forgings. They have replaceable bearing inserts in the crankshaft ends and bronze bushings in the piston ends. The bearing caps on the crankshaft ends are retained by two bolts and nuts through each cap.

*Pistons* – The pistons are machined from an aluminum alloy forging. The piston pin is a full floating type with a plug located in each end of the pin. Depending on the cylinder assembly, pistons may be machined for either three or four rings and may employ either half wedge or full wedge rings. Consult the latest revision of Service Instruction No. 1037 for proper piston and ring combinations.

*Accessory Housing* – The accessory housing is made from an aluminum casting and is fastened to the rear of the crankcase and the top rear of the sump. It forms a housing for the oil pump and the various accessory drives.

**SECTION 1**  
**DESCRIPTION**

**LYCOMING OPERATOR'S MANUAL**  
**TIO-540 SERIES – PARALLEL VALVE CYLINDER HEADS**

*Oil Sump (TIO-540-C1A)* – The sump incorporates an oil drain plug, oil suction screen, mounting pad for fuel injector, the intake riser and intake pipe connections.

*Oil Sump and Induction Assembly (Except TIO-540-C1A)* – This assembly consists of the oil sump bolted to a mated cover containing intake pipe extensions for the induction system. When bolted together they form a mounting pad for the air inlet housing. Fuel drain plugs are provided in the cover and the sump incorporates oil drain plugs and an oil suction screen.

*Cooling System* – These engines are designed to be cooled by air pressure actuated by the forward speed of the aircraft. Baffles are provided to build up a pressure and force the air through the cylinder fins. The air is then exhausted to the atmosphere through gills or augmentor tubes usually located at the rear of the cowling.

*Induction System* – These engines employ a Precision (PAC) RSA type fuel injection system.

The PAC RSA type fuel injection system is based on the principle of measuring air flow and using the air flow signal in a stem type regulator to convert the air force into a fuel force. This fuel force (fuel pressure differential) when applied across the fuel metering section (jetting system) makes fuel flow proportional to air flow.

*Turbocharger System* – A turbocharger is mounted as an integral part of the TIO-540 series engines. The function of the turbocharger is to provide constant air density to the fuel injector inlet from sea level to critical altitude. Regulating the amount of exhaust gas fed to the turbine wheel controls the output which determines engine power. This factor is regulated by the control system which has three components, namely, the density controller, the differential pressure controller and the exhaust bypass valve (waste gate) and the TIO-540-AK1A engine model incorporates a Slope controller. The position of the waste gate is determined by oil pressure acting on a piston which is connected to the butterfly valve by linkage. Increasing oil pressure on the piston closes the waste gate valve and increases power; decreasing oil pressure opens the valve and decreases power. The bleed oil required to activate the piston is controlled by either the density controller or the differential pressure controller.

These controllers each act independently to regulate the pressure on the exhaust bypass piston. The density controller regulates bleed oil at full throttle only. The differential pressure controller takes over whenever part throttle settings are being used. If this unit was not used, the density controller would attempt to position the exhaust bypass so that the air density at the injector entrance was always that required for maximum power. Since this is not required for part throttle operation the differential pressure controller is used to reduce this air pressure and allow the exhaust bypass valve to modulate over as high an operating range as possible.

**NOTE**

*The letter “D” used as the 4<sup>th</sup> or 5<sup>th</sup> character in the model suffix means that the engine is equipped with a dual magneto housed in a single housing. Example – TIO-540-AA1AD.*

# LYCOMING OPERATOR'S MANUAL

## SECTION 2 SPECIFICATIONS

	Page
TIO-540-C1A, -E1A, -G1A.....	2-1
TIO-540-H1A, -AA1AD, -AB1AD, -AB1BD.....	2-2
TIO-540-AF1A, -AF1B, -AG1A, -AK1A.....	2-3
Accessory Drives	
Drive Ratio.....	2-3
Direction of Rotation .....	2-3
Standard Engine Weight .....	2-4

**This Page Intentionally Left Blank**

**SECTION 2  
SPECIFICATIONS**

**TIO-540-C1A**

FAA Type Certificate .....	E14EA
Rated horsepower.....	250 @ 15,000 ft.
Rated speed, RPM.....	2575
Bore, inches.....	5.125
Stroke, inches.....	4.375
Displacement, cubic inches.....	541.5
Compression ratio .....	7.2:1
Firing order .....	1-4-5-2-3-6
Spark occurs, degree BTC .....	20
Valve rocker clearance (hydraulic tappets collapsed) .....	.028-.080
Prop. drive ratio .....	1:1
Prop. driven rotation .....	Clockwise

**TIO-540-E1A**

FAA Type Certificate .....	E14EA
Rated horsepower.....	260 @ 15,000 ft.
Rated speed, RPM.....	2575
Bore, inches.....	5.125
Stroke, inches.....	4.375
Displacement, cubic inches.....	541.5
Compression ratio .....	7.2:1
Firing order .....	1-4-5-2-3-6
Spark occurs, degree BTC .....	20
Valve rocker clearance (hydraulic tappets collapsed) .....	.028-.080
Prop. drive ratio .....	1:1
Prop. driven rotation .....	Clockwise

**TIO-540-G1A**

FAA Type Certificate .....	E14EA
Rated horsepower.....	250 @ 15,000 ft.
Rated speed, RPM.....	2575
Bore, inches.....	5.125
Stroke, inches.....	4.375
Displacement, cubic inches.....	541.5
Compression ratio .....	8.5:1
Firing order .....	1-4-5-2-3-6
Spark occurs, degrees BTC.....	20
Valve rocker clearance (hydraulic tappets collapsed) .....	.028-.080
Prop. drive ratio .....	1:1
Prop. driven rotation .....	Clockwise

**SECTION 2  
SPECIFICATIONS**

**LYCOMING OPERATOR'S MANUAL  
TIO-540 SERIES – PARALLEL VALVE CYLINDER HEADS**

**SPECIFICATIONS (CONT.)**

**TIO-540-H1A**

FAA Type Certificate .....	E14EA
Rated horsepower.....	270 @ 15,000 ft.
Rated speed, RPM.....	2575
Bore, inches.....	5.125
Stroke, inches.....	4.375
Displacement, cubic inches.....	541.5
Compression ratio .....	7.2:1
Firing order .....	1-4-5-2-3-6
Spark occurs, degrees BTC.....	20
Valve rocker clearance (hydraulic tappets collapsed) .....	.028-.080
Prop. drive ratio .....	1:1
Prop. driven rotation .....	Clockwise

**TIO-540-AA1AD**

FAA Type Certificate .....	E14EA
Rated horsepower.....	270 @ 15,000 ft.
Rated speed, RPM.....	2575
Bore, inches.....	5.125
Stroke, inches.....	4.375
Displacement, cubic inches.....	541.5
Compression ratio .....	8.0:1
Firing order .....	1-4-5-2-3-6
Spark occurs, degrees BTC.....	20
Valve rocker clearance (hydraulic tappets collapsed) .....	.028-.080
Prop. drive ratio .....	1:1
Prop. driven rotation .....	Clockwise

**TIO-540-AB1AD, -AB1BD**

FAA Type Certificate .....	E14EA
Rated horsepower.....	250 @ 15,000 ft.
Rated speed, RPM.....	2575
Bore, inches.....	5.125
Stroke, inches.....	4.375
Displacement, cubic inches.....	541.5
Compression ratio .....	8.0:1
Firing order .....	1-4-5-2-3-6
Spark occurs, degrees BTC.....	20
Valve rocker clearance (hydraulic tappets collapsed) .....	.028-.080
Prop. drive ratio .....	1:1
Prop. driven rotation .....	Clockwise



**SPECIFICATIONS (CONT.)**

**TIO-540-AF1A, -AF1B, -AG1A**

FAA Type Certificate .....	E14EA
Rated horsepower.....	270 @ 20,000 ft.
Rated speed, RPM.....	2575
Bore, inches.....	5.125
Stroke, inches.....	4.375
Displacement, cubic inches.....	541.5
Compression ratio .....	8.0:1
Firing order .....	1-4-5-2-3-6
Spark occurs, degrees BTC.....	20
Valve rocker clearance (hydraulic tappets collapsed) .....	.028-.080
Prop. drive ratio .....	1:1
Prop. driven rotation .....	Clockwise

**TIO-540-AK1A**

FAA Type Certificate .....	E14EA
Rated horsepower.....	235
Rated speed, RPM.....	2400
Bore, inches.....	5.125
Stroke, inches.....	4.375
Displacement, cubic inches.....	541.5
Compression ratio .....	8.0:1
Firing order .....	1-4-5-2-3-6
█ Spark occurs, degrees BTC.....	23♦
Valve rocker clearance (hydraulic tappets collapsed) .....	.028-.080
Prop. drive ratio .....	1:1
Prop. driven rotation .....	Clockwise

█ ♦ NOTE: On some older engines the magneto spark timing occurs at 20°BTC. Consult the engine data plate before timing magnetos.

*Accessory Drive	Drive Ratio	**Direction of Rotation
Starter	16.556:1	Counterclockwise
Generator	1.910:1	Clockwise
Generator (Optional)	2.500:1	Clockwise
Alternator	3.200:1	Clockwise
Alternator (Optional)	3.630:1	Clockwise
Vacuum Pump	1.300:1	Counterclockwise
Hydraulic Pump	1.385:1	Clockwise
Hydraulic Pump†	1.300:1	Clockwise
Tachometer	.500:1	Clockwise
Propeller Governor	.895:1	Clockwise
Propeller Governor‡	.947:1	Clockwise

\* - When applicable.

\*\* - Viewed facing drive pad

† - Dual magneto engines.

‡ - Wide cylinder flange engines.

**SECTION 2  
SPECIFICATIONS**

**LYCOMING OPERATOR'S MANUAL  
TIO-540 SERIES – PARALLEL VALVE CYLINDER HEADS**

**SPECIFICATIONS (CONT.)**

*Accessory Drive	Drive Ratio	**Direction of Rotation
Magneto Drive: Single	1.500:1	Clockwise
Magneto Drive: Dual	.750:1	Clockwise
Fuel Pump - AN♦	1.000:1	Counterclockwise
Fuel Pump – Plunger Operated	.500:1	Counterclockwise

\* - When applicable.

\*\* - Viewed facing drive pad.

♦ - Fuel pump drive has clockwise rotation on dual magneto engines.

*1. STANDARD ENGINE, DRY WEIGHT*

MODEL	LBS.
TIO-540-AK1A.....	472
TIO-540-AB1AD, -AB1BD .....	474
TIO-540-C1A, -E1A, -G1A, -H1A, -AA1AD.....	484
TIO-540-AG1A.....	485
TIO-540-AF1A .....	491
TIO-540-AF1B .....	493

# LYCOMING OPERATOR'S MANUAL

## SECTION 3 OPERATING INSTRUCTIONS

	Page
General.....	3-1
Prestarting Items of Maintenance .....	3-1
Starting Procedures .....	3-1
Cold Weather Starting .....	3-2
Ground Running and Warm-Up .....	3-2
Ground Check .....	3-3
Operating in Flight .....	3-4
Leaning Procedure.....	3-4
Engine Flight Chart .....	3-5
Operating Conditions .....	3-7
Engine Shut-Down Procedure .....	3-9
Performance Curves .....	3-10

**This Page Intentionally Left Blank**

### SECTION 3

#### OPERATING INSTRUCTIONS

1. *GENERAL.* Close adherence to these instructions will greatly contribute to long life, economy and satisfactory operation of the engine.

#### NOTE

*YOUR ATTENTION IS DIRECTED TO THE WARRANTIES THAT APPEAR IN THE FRONT OF THIS MANUAL REGARDING ENGINE SPEED, THE USE OF SPECIFIED FUELS AND LUBRICANTS, REPAIRS AND ALTERATIONS. PERHAPS NO OTHER ITEMS OF ENGINE OPERATION AND MAINTENANCE CONTRIBUTES QUITE SO MUCH TO SATISFACTORY PERFORMANCE AND LONG LIFE AS THE CONSTANT USE OF CORRECT GRADES OF FUEL AND OIL, CORRECT ENGINE TIMING, AND FLYING THE AIRCRAFT AT ALL TIMES WITHIN THE SPEED AND POWER RANGE SPECIFIED FOR THE ENGINE. DO NOT FORGET THAT VIOLATION OF THE OPERATION AND MAINTENANCE SPECIFICATIONS FOR YOUR ENGINE WILL NOT ONLY VOID YOUR WARRANTY BUT WILL SHORTEN THE LIFE OF YOUR ENGINE AFTER ITS WARRANTY PERIOD HAS PASSED.*

New engines have been carefully run-in by Lycoming and therefore, no further break-in is necessary insofar as operation is concerned. New or newly overhauled engines should be operated using only the lubricating oils recommended in the latest revision of Service Instruction No. 1014.

#### NOTE

*Cruising should be done at 65% to 75% power until a total of 50 hours has accumulated or oil consumption has stabilized. This is to insure proper seating of the rings and is applicable to new engines, and engines in service following cylinder replacement or top overhaul of one or more cylinders.*

The minimum fuel octane rating is listed in the flight chart, Part 8 of this section. Under no circumstances should fuel of a lower octane rating or automotive fuel (regardless of octane rating) be used.

2. *PRESTARTING ITEMS OF MAINTENANCE.* Before starting the aircraft engine for the first flight of the day, there are several items of maintenance inspection that should be performed. These are described in Section 4 under Daily Pre-Flight Inspection. They must be observed before the engine is started.

3. *STARTING PROCEDURES.*

The following starting procedures are recommended; however, the starting characteristics of various installations will necessitate some variation from these procedures.

#### NOTE

*Cranking periods should be limited to ten (10) to twelve (12) seconds with 5 minutes rest between cranking periods.*

*a. TIO-540 Series (Cold Engine).*

- (1) Perform pre-flight inspection.
- (2) Set propeller governor in “Full RPM.
- (3) Turn fuel valve to “on” position.
- (4) Open throttle approximately  $\frac{1}{4}$  travel.
- (5) Turn boost pump on and move mixture control to “Full Rich” position until a slight but steady flow is indicated.
- (6) Return mixture control to “Idle Cut-Off” position.
- (7) Set magneto selector switch. Consult airframe manufacturer’s handbook for correct position.
- (8) Engage starter.
- (9) When engine starts, place magneto selector switch in “Both” position.
- (10) Move mixture control slowly and smoothly to “Full Rich”
- (11) Check oil pressure gage for indicated pressure. If oil pressure is not indicated within thirty seconds, stop the engine and determine trouble.

*NOTE*

*If engine fails to achieve a normal start, assume it to be flooded and use standard clearing procedure. Then repeat above procedure.*

- b. Hot Engine* – Because of the fact that the fuel percolates and the system must be cleared of vapor, it is recommended that the same procedure, as outlined above, be used for starting a hot engine.

**4. COLD WEATHER STARTING.** During extreme cold weather, it may be necessary to preheat the engine and oil before starting.

**5. GROUND RUNNING AND WARM-UP.** Subject engines are air pressure cooled and depend on the forward movement of the aircraft to maintain proper cooling. Particular care is necessary, therefore, when operating these engines on the ground. To prevent overheating, it is recommended that the following precautions be observed.

*NOTE*

*Any ground check that requires full throttle operation must be limited to three minutes, or less if indicated cylinder head temperature should exceed the maximum stated in this manual.*

- a. Head the aircraft into the wind.
  - b. Leave mixture in “Full Rich”.
  - c. Operate the engine on the ground only with the propeller in minimum blade angle setting.
  - d. Warm up at approximately 1000-1200 RPM. Avoid prolonged idling and do not exceed 2200 RPM on the ground.
  - e. Engine is warm enough for take-off when the throttle can be opened without the engine faltering. Take-off with turbocharged engines should not be started if indicated lubricating oil pressure due to cold temperature, is above maximum. Excessive oil pressure can cause over boost and consequent engine damage.
6. *GROUND CHECK.*
- a. Warm up as directed above.
  - b. Check both oil pressure and oil temperature.
  - c. Leave mixture in “Full Rich”.
  - d. (Where applicable.) Move the propeller control through its complete range to check operation and return to full low pitch position. Full feathering check (twin engine) on the ground is not recommended but the feathering action can be checked by running the engine between 1000-1500 RPM; then momentarily pulling the propeller control into the feathering position. Do not allow the RPM to drop more than 500 RPM.
  - e. A proper magneto check is important. Additional factors, other than the ignition system, affect magneto drop-off. They are load-power output, propeller pitch and mixture strength. The important thing is that the engine runs smoothly because magneto drop-off is affected by the variables listed above. Make the magneto check in accordance with the following procedures.
    - (1) (Controllable Pitch Propeller) With the propeller in minimum pitch angle, set the engine to produce 50-65% power as indicated by the manifold pressure gage. Mixture control should be in the full rich position. At these settings, the ignition system and spark plugs must work harder because of the greater pressure within the cylinders. Under these conditions, ignition problems, if they exist, will occur. Mag checks at low power settings will only indicate fuel-air distribution quality.

*NOTE*

*Aircraft that are equipped with fixed pitch propeller, or not equipped with manifold pressure gage, may check magneto drop-off with engine operating at approximately 2100-2200 RPM.*

- (2) Switch from both magnetos to one and note drop-off, return to both until engine regains speed and switch to the other magneto and note drop-off, then return to both. Drop-off should not exceed 175 RPM and should not exceed 50 RPM between magnetos. A smooth drop-off past normal is usually a sign of a too lean or to rich mixture.

- f. Do not operate on a single magneto for too long a period, a few seconds is usually sufficient to check drop-off and will minimize plug fouling.

**7. OPERATING IN FLIGHT.**

- a. Subject engines are equipped with a dynamic counterweight system and must be operated accordingly. Use a smooth, steady movement (avoid rapid opening and closing) of the throttle.
- b. See airframe manufacturer's instructions for recommended power settings.
- c. Fuel Mixture Leaning Procedure.

Improper fuel/air mixture during flight is responsible for many engine problems, particularly during take-off and climb power settings. The procedures described in this manual provide proper fuel/air mixture when leaning Lycoming engines; they have proven to be both economical and practical by eliminating excessive fuel consumption and reducing damaged parts replacement. It is therefore recommended that operators of all Lycoming aircraft power-plants utilize the instructions in this publication any time the fuel/air mixture is adjusted during flight.

Manual leaning may be monitored by exhaust gas temperature indication, fuel flow indication, and by observation of engine speed and/or airspeed. However, whatever instruments are used in leaning the mixture, the following general rules should be observed by the operator of Lycoming aircraft engines.

**GENERAL RULES**

*Never exceed the maximum red line cylinder head temperature limit.*

*For maximum service life, cylinder head temperatures should be maintained below 435°F (224°C) during high performance cruise operation and below 400°F (205°C) for economy cruise powers.*

*All take-offs are to be made with the mixture controls in the full rich position regardless of field elevation. Turbocharging permits the engine to develop rating power regardless of field elevation. However, it may be necessary to manually lean the engine for ground operation at idle or off idle engine speeds.*

*Leaning during climb, usually 85% of rated power, is permitted only if and to the limits described in the aircraft operator's handbook. Engine temperature instruments must be monitored and temperatures must be maintained within the prescribed limits.*

*Maximum cruise power setting not to exceed 75%.*

*During let-down flight operations it may be necessary to manually lean engine to obtain smooth operation.*

*On turbocharged engines never exceed 1650°F turbine inlet temperature (TIT).*



**1. LEANING TO TURBINE INLET TEMPERATURE OR EXHAUST GAS TEMPERATURE GAGE.**

*a. Turbocharged Engines.*

- (1) *Best Economy Cruise – Lean to peak turbine inlet temperature (TIT) or 1650°F, whichever occurs first.*
- (2) *Maximum Power Cruise – The engine must always be operated on the rich side of peak TIT. Before leaning to obtain maximum power mixture it is necessary to establish a reference point. This is accomplished as follows:*
  - (a) *Establish a peak TIT for best economy operation at the highest economy cruise power without exceeding 1650°F.*
  - (b) *Deduct 125°F from this temperature and thus establish the temperature reference point for use when operating at maximum power mixture.*
  - (c) *Return mixture control to full rich and adjust the RPM and manifold pressure for desired performance cruise operation.*
  - (d) *Lean out mixture until TIT is the value established in Step (b). This sets the mixture at best power.*

**2. LEANING TO FLOWMETER.**

*Lean to applicable fuel-flow tables or lean to indicator marked for correct fuel-flow for each power setting.*

**3. LEANING WITH MANUAL MIXTURE CONTROL (Without flowmeter or TIT gage).**

- a. Slowly move mixture control from “Full Rich” position toward lean position.*
- b. Continue leaning until slight loss of power is noted (loss of power may or may not be accompanied by roughness).*
- c. Enrich until engine runs smoothly and power is regained*

**8. ENGINE FLIGHT CHART.**

FUEL - \*Aviation Grade Fuel  
 All Models .....100/100LL octane, minimum

\* - Refer to latest revision of Service Instruction No. 1070.

OIL – (All Models) – \*Recommended Grade Oil

	MIL-L-6082B SAE Grades	MIL-L-22851 or SAEJ1899 Ashless Dispersant SAE Grades
Average Ambient Temperature		
All temperatures	---	15W-50 or 20W-50
Above 80°F	60	60
Above 60°F	50	40 or 50
30°F to 90°F	40	40
0°F to 70°F	30	30, 40 or 20W-40
Below 10°F	20	30 or 20W-30

\* - Refer to the latest revision of Service Instruction No. 1014.

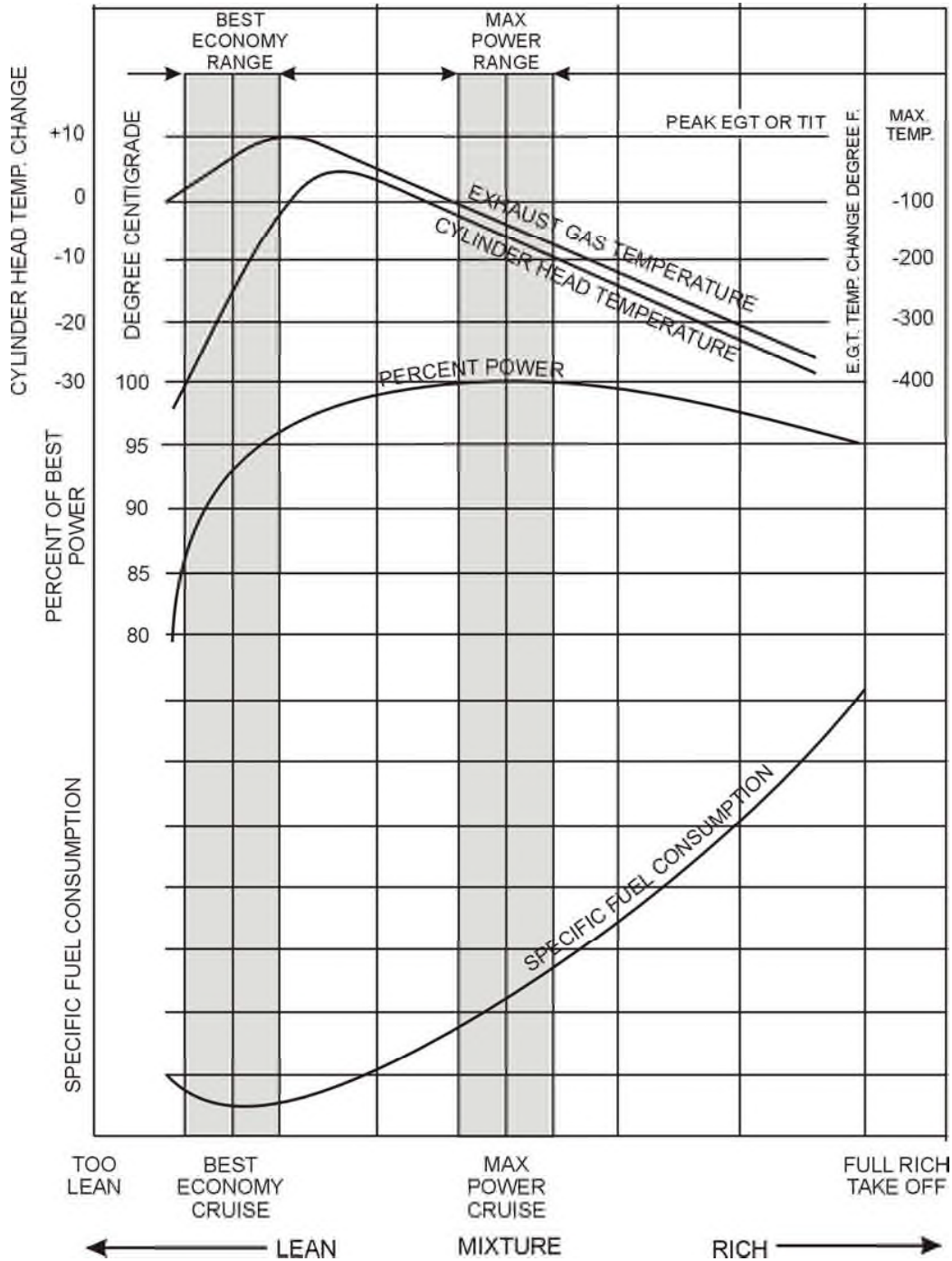

Figure 3-1. Representative Effect of Leaning on Cylinder Head Temperature, EGT (Exhaust Gas Temperature) or TIT (Turbine Inlet Temperature), Engine Power and Specific Fuel Consumption at Constant Engine RPM and Manifold Pressure

OIL – (All Models) (Cont.) –

Oil Sump Capacity	Maximum	Minimum Safe Quantity
TIO-540-AK1A	8 U.S. Quarts	4 U.S. Quarts
TIO-540-C1A, -E1A, -G1A, -H1A	12 U.S. Quarts	2-3/4 U.S. Quarts
TIO-540-AA1AD, -AF1A, -AF1B, -AG1A	10 U.S. Quarts	4 U.S. Quarts
TIO-540-AB1AD, -AB1BD	12 U.S. Quarts	4 U.S. Quarts

**OPERATING CONDITIONS**

Average Ambient Air	Desired	*Oil Inlet Temperature Maximum
Above 60°F	180°F (82°C)	245°F (118°C)
30°F to 90°F	180°F (82°C)	245°F (118°C)
0°F to 70°F	170°F (77°C)	245°F (118°C)
Below 10°F	160°F (71°C)	245°F (118°C)

\* - Engine oil temperature should not be below 140°F (60°C) during continuous operation.

OIL PRESSURE – PSI –

Normal Operation	Maximum	Minimum	Idling	Start and Warm-Up
All Models	95	55	25	115

FUEL PRESSURE – PSI –

	MIN.	MAX.	IDLE MIN.
TIO-540-C1A, -E1A, -G1A, -H1A			
Inlet to fuel pump	-2	55	
Inlet to fuel injector	18	65	12
TIO-540-AA1AD, -AF1A, -AF1B			
Inlet to fuel pump	-2	55	
Inlet to fuel injector	24	55	12
TIO-540-AG1A, -AK1A			
Inlet to fuel pump	-2	55	
Inlet to fuel injector	20	55	12
TIO-540-AB1AD, -AB1BD			
Inlet to fuel pump	-2	55	
Inlet to fuel injector	20	65	12

**OPERATING CONDITIONS (CONT.)**

Operation	RPM	HP	Fuel Cons. Gal./Hr.	Max. Oil Cons. Qts./Hr.	**Max. Cyl. Head Temp.
<b>*TIO-540-C1A</b>					
Normal Rated Performance Cruise (75% Rated)	2575	250	-----	1.12	500°F (260°C)
Economy Cruise (60% Rated)	2350	190	15.5	0.63	500°F (260°C)
	2200	150	11.5	0.50	500°F (260°C)
<b>*TIO-540-E1A</b>					
Normal Rated Performance Cruise (75% Rated)	2575	260	-----	1.16	500°F (260°C)
Economy Cruise (60% Rated)	2350	195	16.0	0.65	500°F (260°C)
	2200	155	12.0	0.52	500°F (260°C)
<b>*TIO-540-G1A</b>					
Normal Rated Performance Cruise (75% Rated)	2575	250	-----	1.11	500°F (260°C)
Economy Cruise (60% Rated)	2350	190	15.5	0.63	500°F (260°C)
	2200	150	11.5	0.50	500°F (260°C)
<b>*TIO-540-H1A</b>					
Normal Rated Performance Cruise (75% Rated)	2575	270	-----	1.20	500°F (260°C)
Economy Cruise (60% Rated)	2350	203	17.5	0.68	500°F (260°C)
	2250	152	13.4	0.54	500°F (260°C)
<b>*TIO-540-AA1AD</b>					
Normal Rated Performance Cruise (75% Rated)	2575	270	29.3	0.90	500°F (260°C)
Economy Cruise (60% Rated)	2400	200	17.1	0.67	500°F (260°C)
	2200	160	11.7	0.54	500°F (260°C)

\* - MAXIMUM TURBINE INLET TEMPERATURE 1650°F (898.8°C).

\*\* - At Bayonet Location – For maximum service life of the engine maintain cylinder head temperature between 150°F (65.6°C) and 435°F (223.8°C) for continuous operation.

**OPERATING CONDITIONS (CONT.)**

Operation	RPM	HP	Fuel Cons. Gal./Hr.	Max. Oil Cons. Qts./Hr.	**Max. Cyl. Head. Temp.
<b>*TIO-540-AB1AD, -AB1BD</b>					
Normal Rated	2575	250	25.4	0.83	500°F (260°C)
Performance Cruise (75% Rated)	2400	190	16.1	0.63	500°F (260°C)
Economy Cruise (60% Rated)	2200	150	11.7	0.50	500°F (260°C)
<b>†TIO-540-AF1A, -AF1B, *-AG1A</b>					
Normal Rated	2575	270	27.5	0.90	500°F (260°C)
Performance Cruise (75% Rated)	2400	200	17.1	0.67	500°F (260°C)
Economy Cruise (60% Rated)	2200	160	12.5	0.54	500°F (260°C)
<b>*TIO-540-AK1A</b>					
Normal Rated	2400	235	24.0	0.80	500°F (260°C)
Performance Cruise (75% Rated)	2400	206	15.0	0.70	500°F (260°C)
Economy Cruise (60% Rated)	2400	176	11.0	0.60	500°F (260°C)

\* - MAXIMUM TURBINE INLET TEMPERATURE 1650°F (898.8°C).

† - MAXIMUM TURBINE INLET TEMPERATURE 1750°F (943°C).

\*\* - At Bayonet Location – For maximum service life of the engine maintain cylinder head temperature between 150°F (65.6°C) and 435°F (223.8°C) during continuous operation.

*e. Engine Shut-Down Procedure.*

- (1) Set propeller at minimum blade angle (high RPM).
- (2) Idle until there is a decided decrease in cylinder head temperature.
- (3) Move mixture control to “Idle Cut-Off”.
- (4) When engine stops, turn ignition switch off.

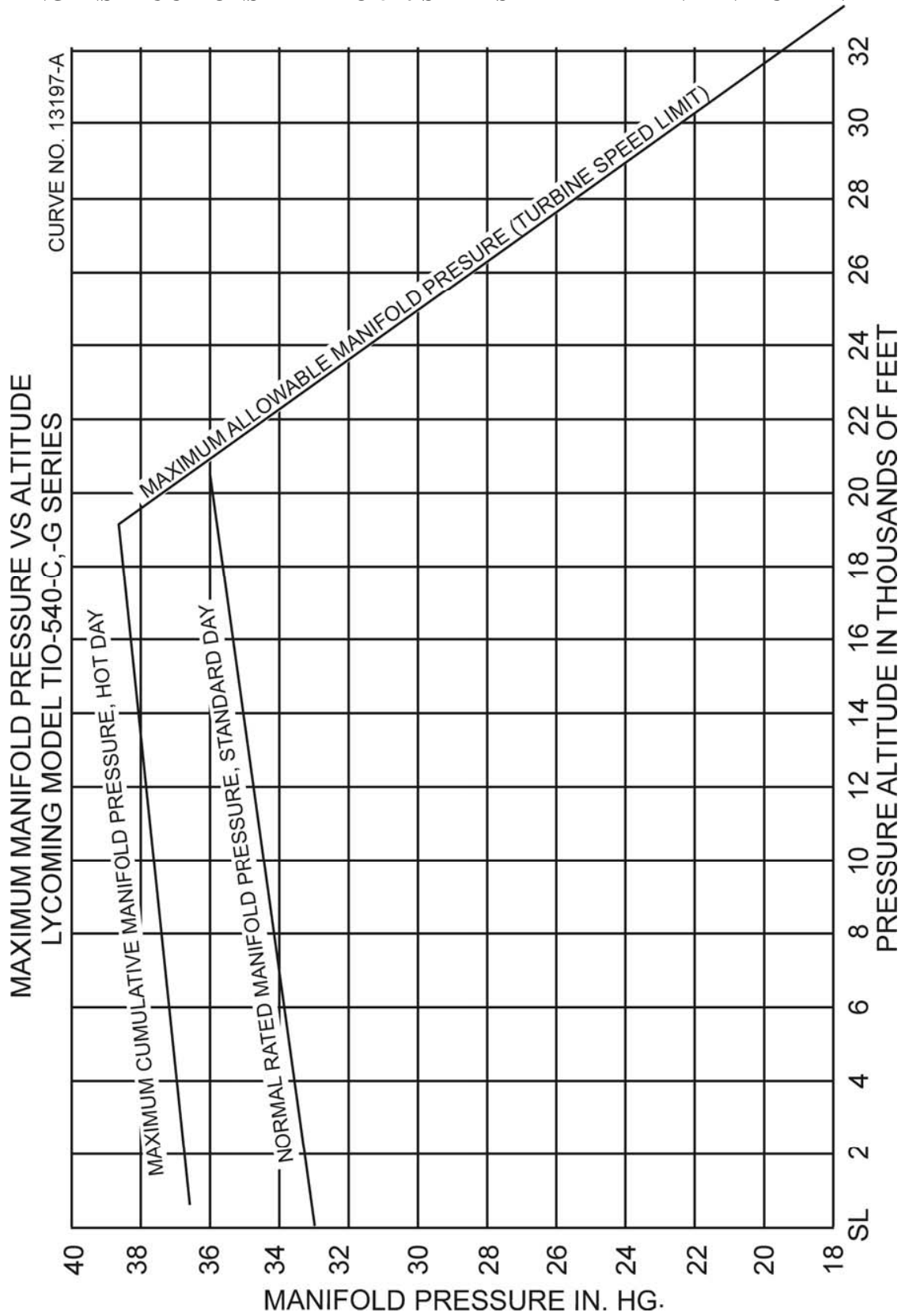

Figure 3-2. Limiting Manifold Pressure vs Altitude – TIO-540-C1A, -G1A

PART THROTTLE FUEL CONSUMPTION  
 LYCOMING MODEL TIO-540-C SERIES

COMPRESSION RATIO 7.30:1  
 SPARK TIMING 20° BTC  
 FUEL INJECTOR BENDIX MODEL RSA-5AD1  
 MIXTURE CONTROL-MANUAL TO BEST ECONOMY  
 OR BEST POWER AS INDICATED  
 FUEL GRADE, MINIMUM 100/130

CURVE NO. 13106

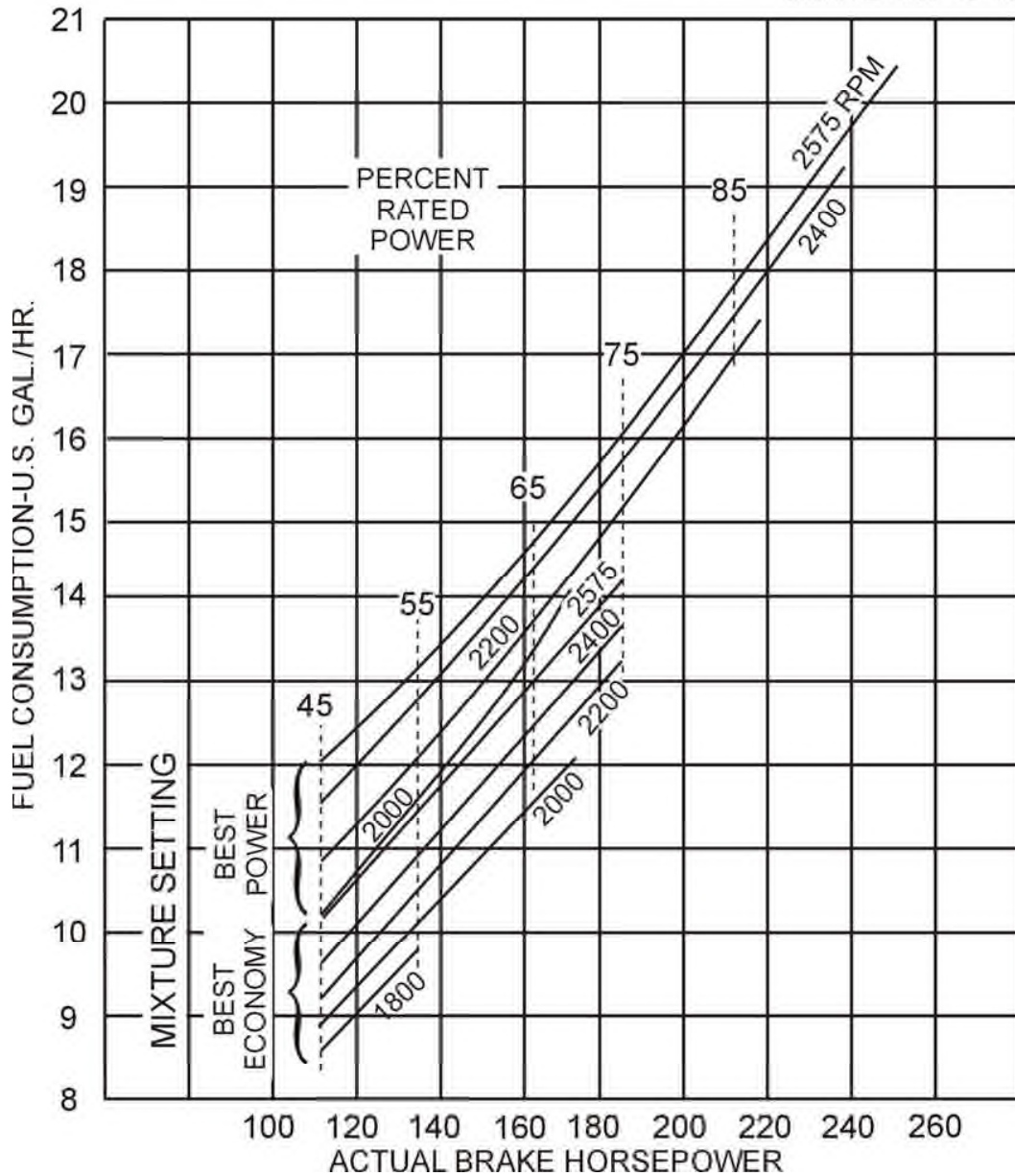

Figure 3-3. Part Throttle Fuel Consumption – TIO-540-C1A

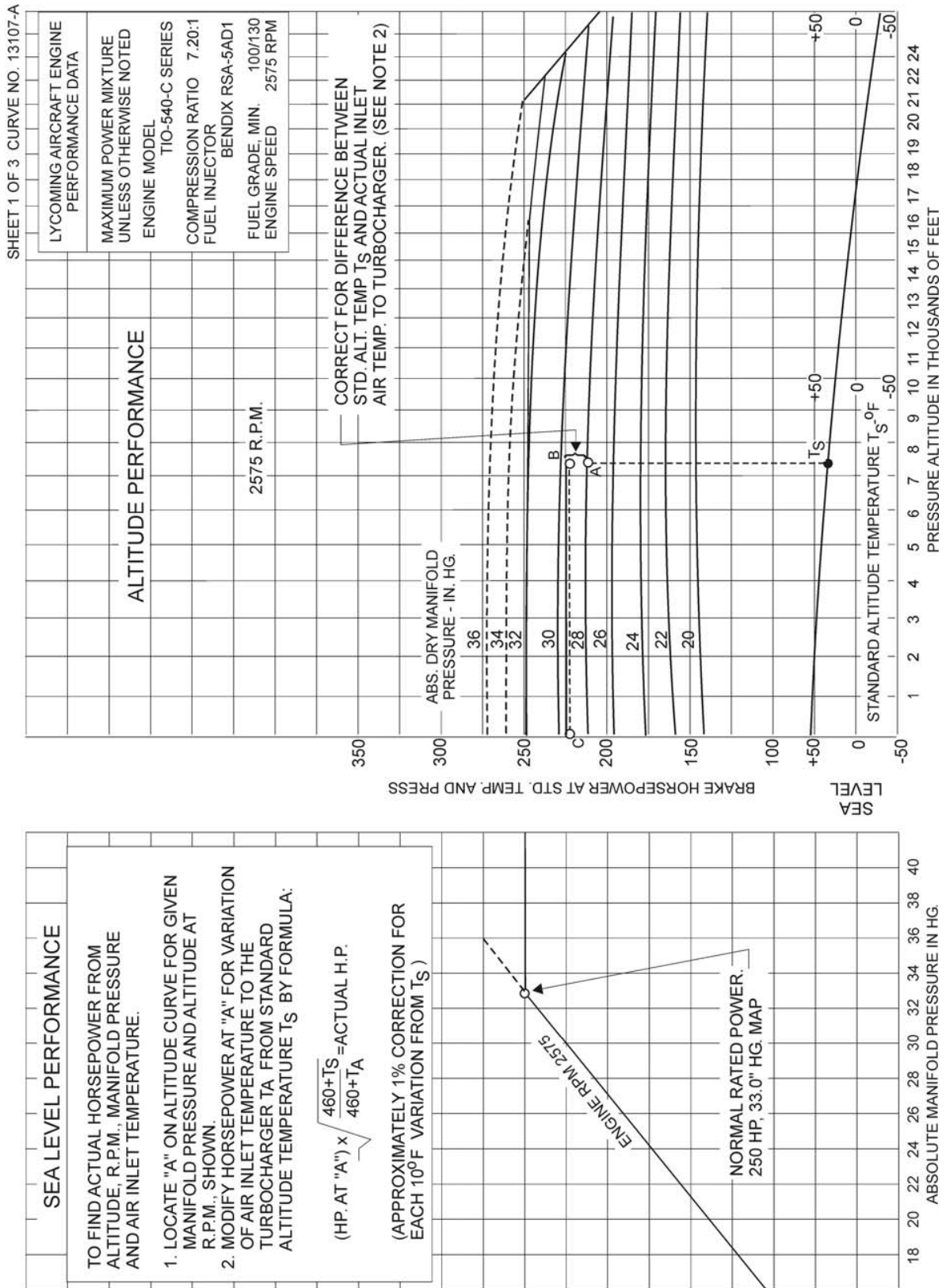

Figure 3-4. Sea Level/Altitude Performance Curve – TIO-540-C1A (Sheet 1 of 3)



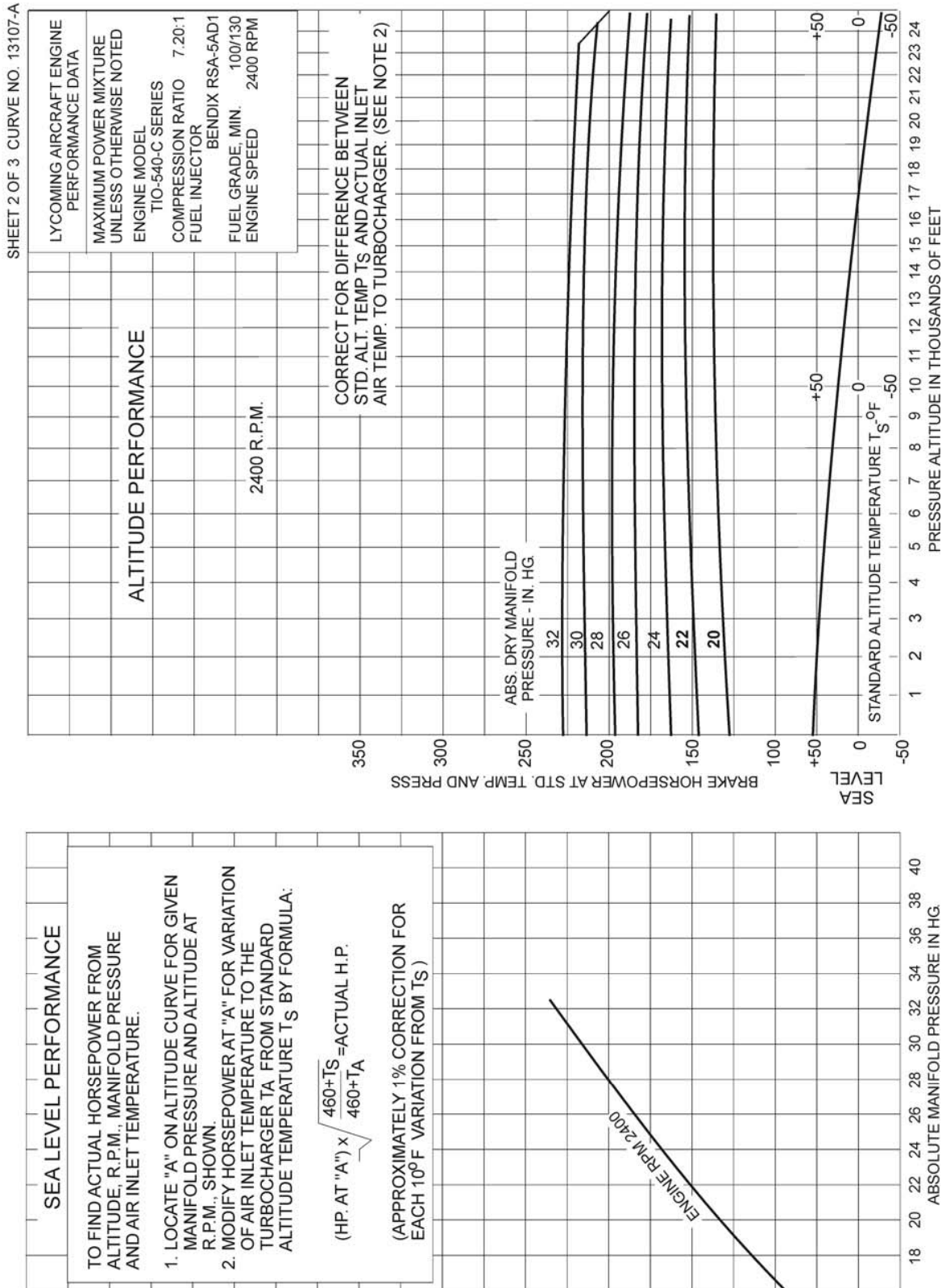

Figure 3-5. Sea Level/Altitude Performance Curve – TIO-540-C1A (Sheet 2 of 3)

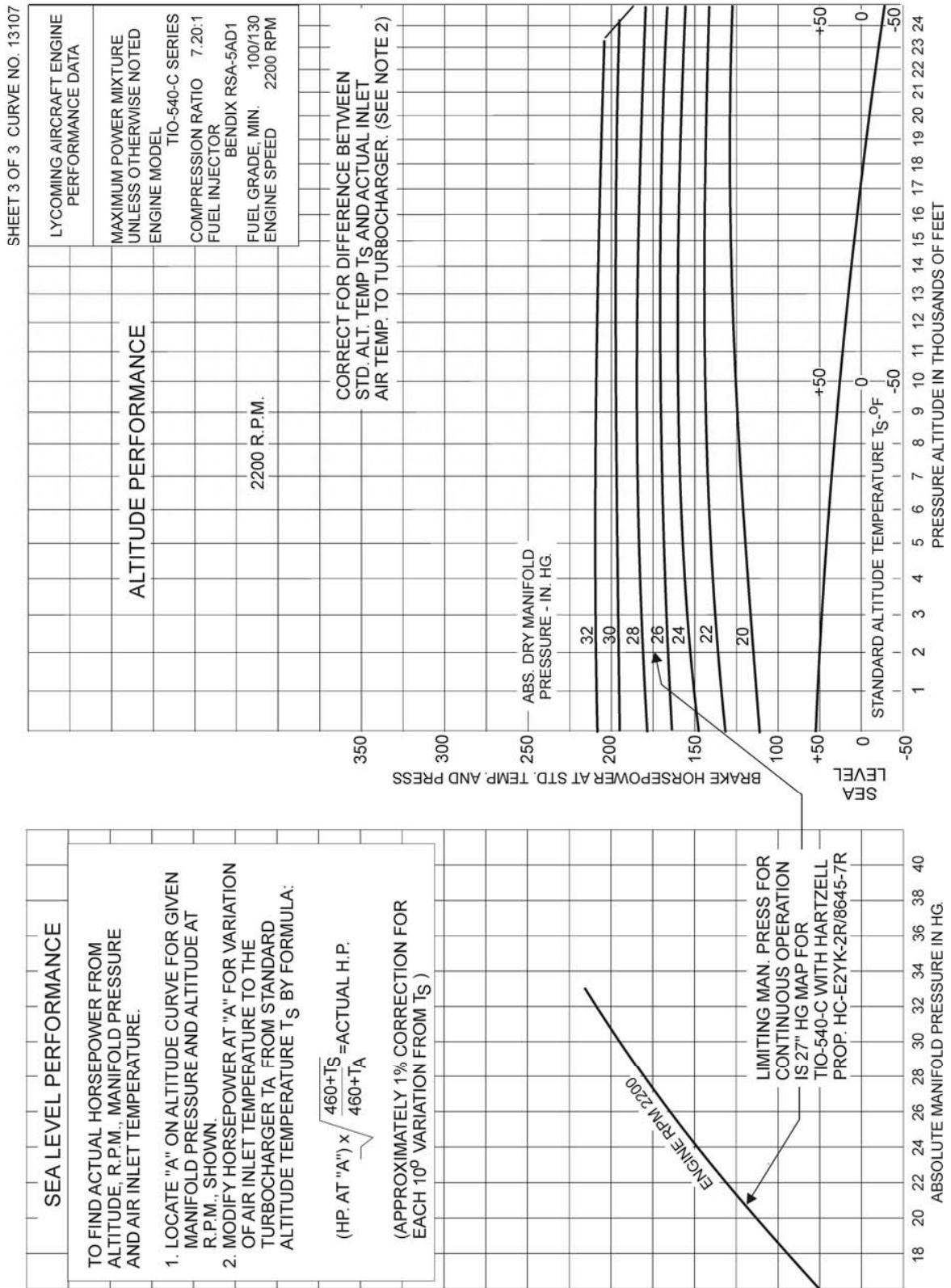

Figure 3-6. Sea Level/Altitude Performance Curve – TIO-540-C1A (Sheet 3 of 3)

FUEL FLOW vs PERCENT RATED POWER  
LYCOMING MODEL TIO-540-E SERIES

COMPRESSION RATIO	7.20:1
SPARK ADVANCE	20°BTC
FUEL INJECTOR	BENDIX RSA-5AD1
TURBOCHARGER	AIRESEARCH TE0659
MIXTURE CONTROL-MANUAL TO FLOWMETER GAGE	
FUEL GRADE, MINIMUM	100/130

CURVE NO. 13171

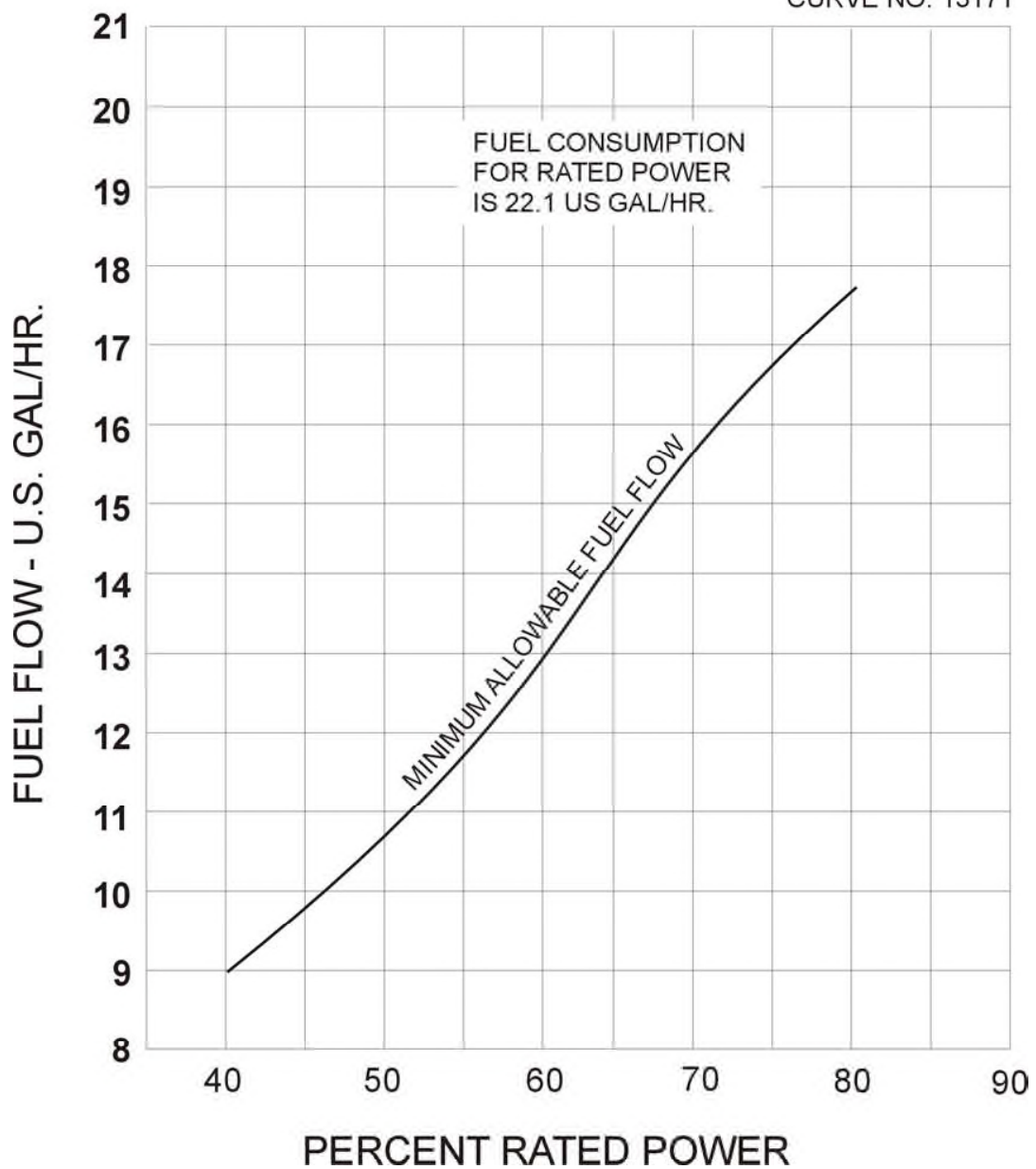

Figure 3-7. Fuel Flow vs Percent Rated Power – TIO-540-E1A

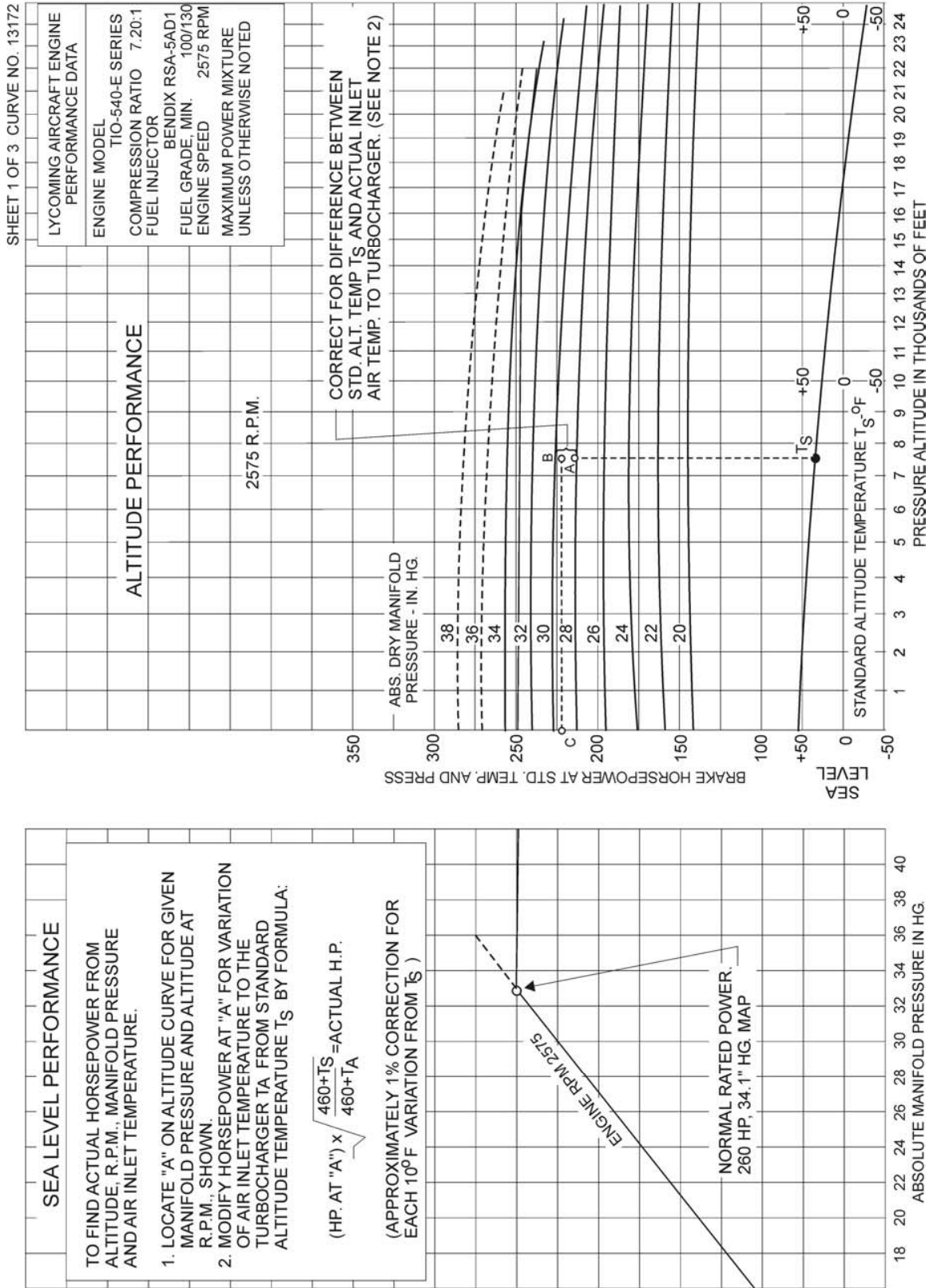

Figure 3-8. Sea Level/Altitude Performance Curve – TIO-540-E1A (Sheet 1 of 3)

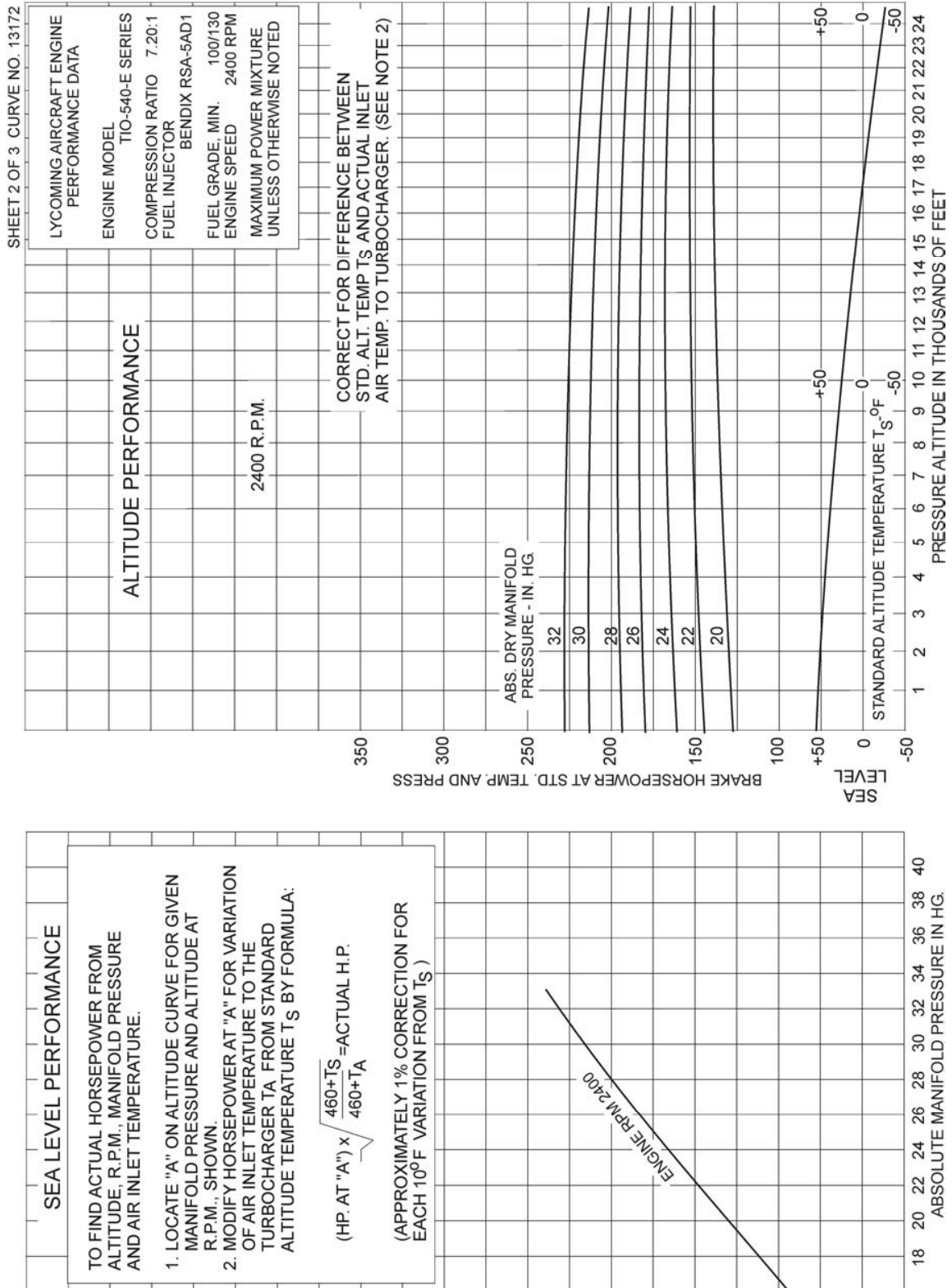

Figure 3-9. Sea Level/Altitude Performance Curve – TIO-540-E1A (Sheet 2 of 3)

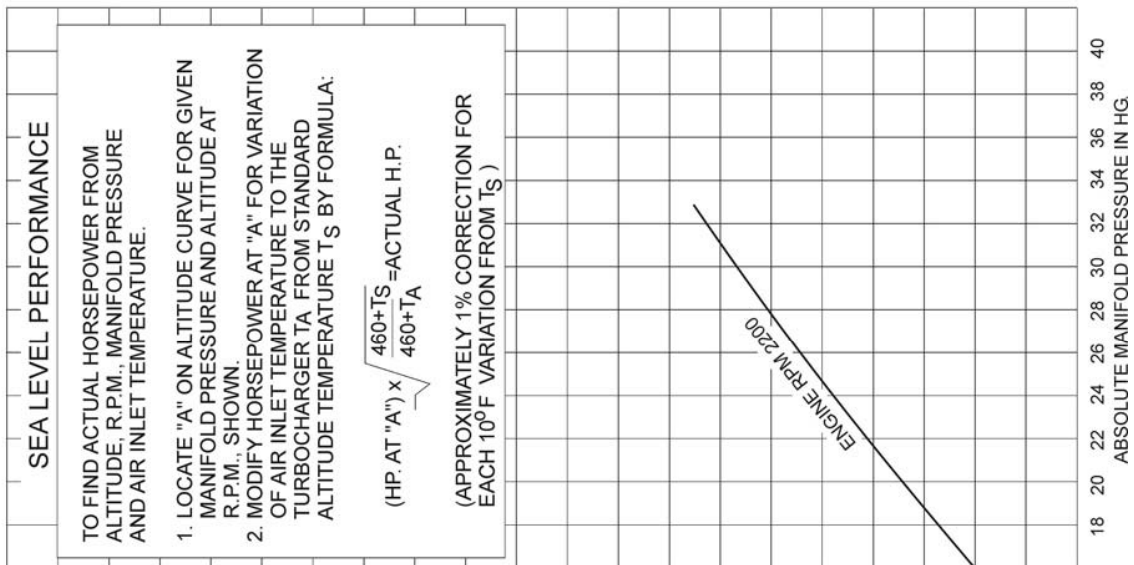
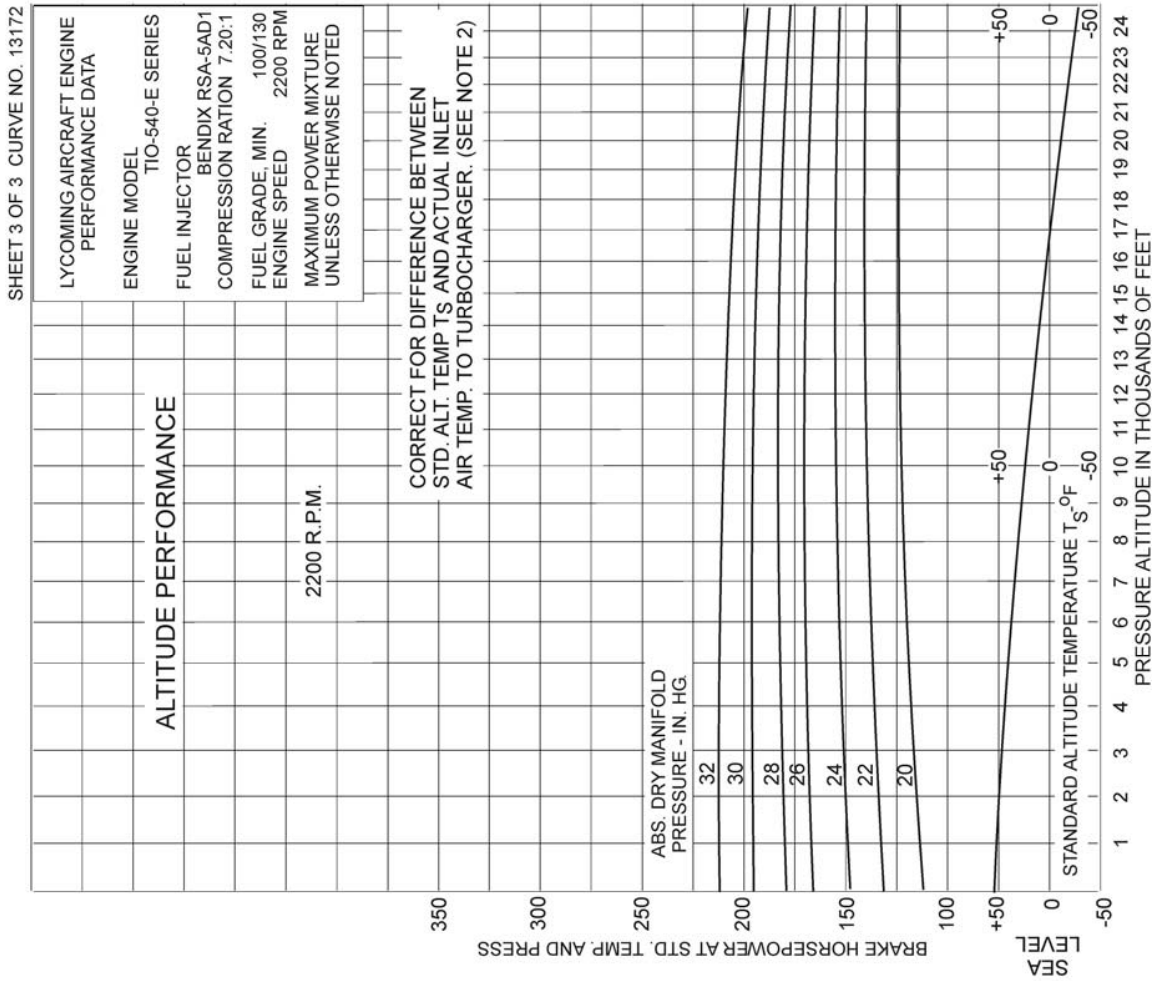

Figure 3-10. Sea Level/Altitude Performance Curve – TIO-540-E1A (Sheet 3 of 3)

FUEL FLOW vs PERCENT RATED POWER  
LYCOMING MODEL TIO-540-G SERIES

COMPRESSION RATIO 8.50:1  
SPARK ADVANCE 20° BTC  
FUEL INJECTOR BENDIX RSA-5AD1  
TURBOCHARGER AIRESEARCH TE0659  
MIXTURE CONTROL-MANUAL TO FLOWMETER GAGE  
FUEL GRADE, MINIMUM 100/130

CURVE NO. 13189

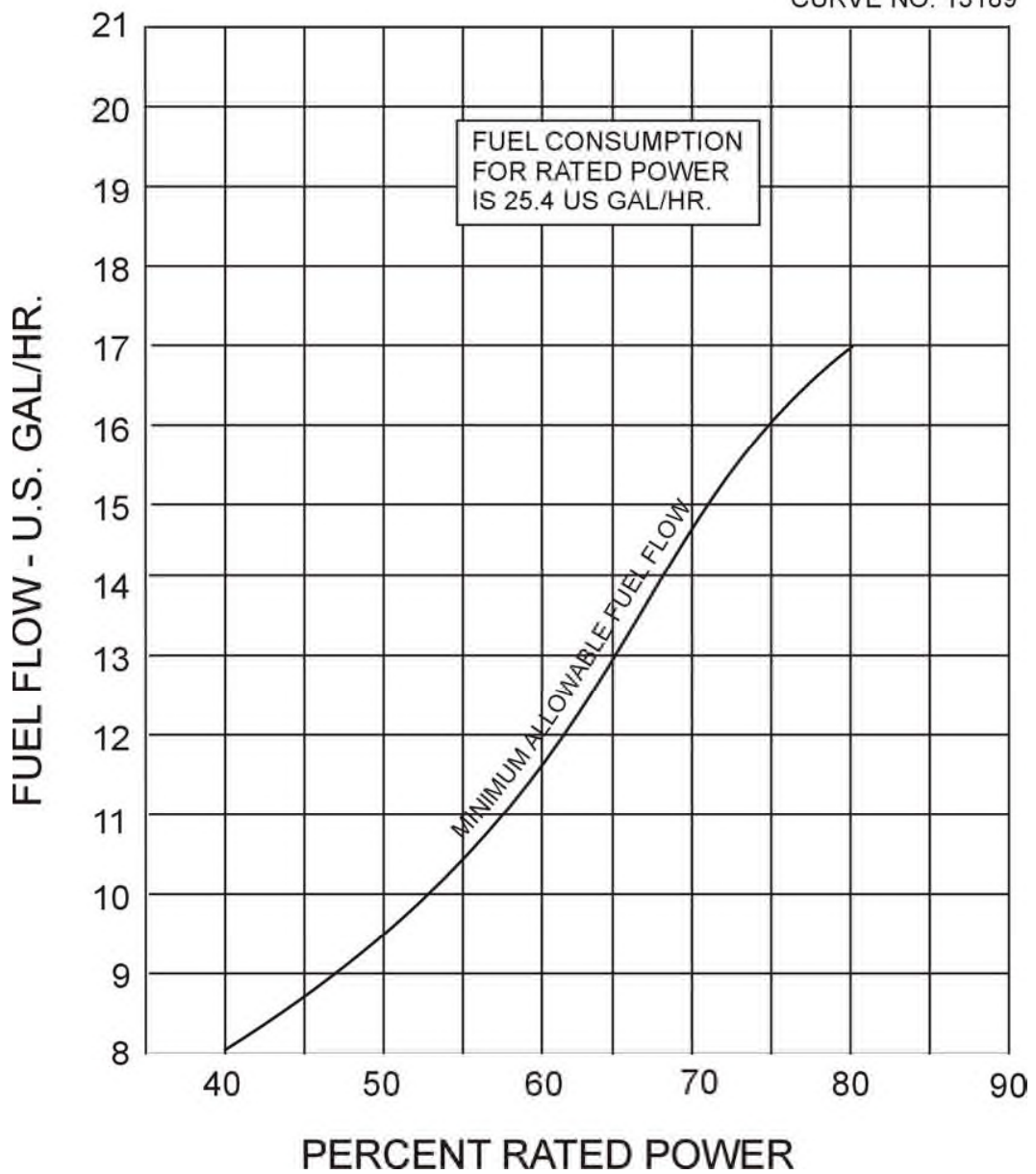

Figure 3-11. Fuel Flow vs Percent Rated Power – TIO-540-G1A

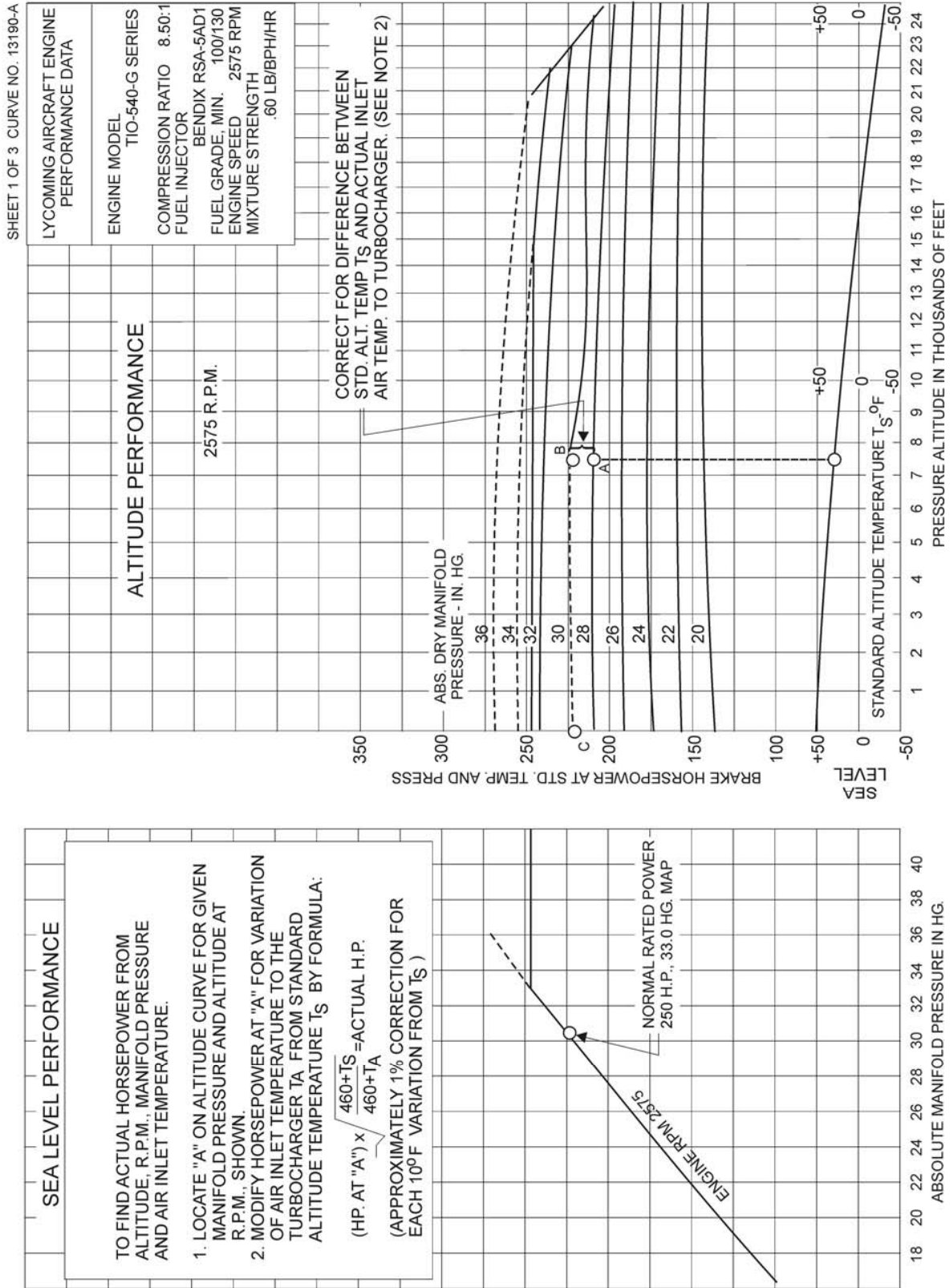

Figure 3-12. Sea Level/Altitude Performance Curve – TIO-540-G1A (Sheet 1 of 3)



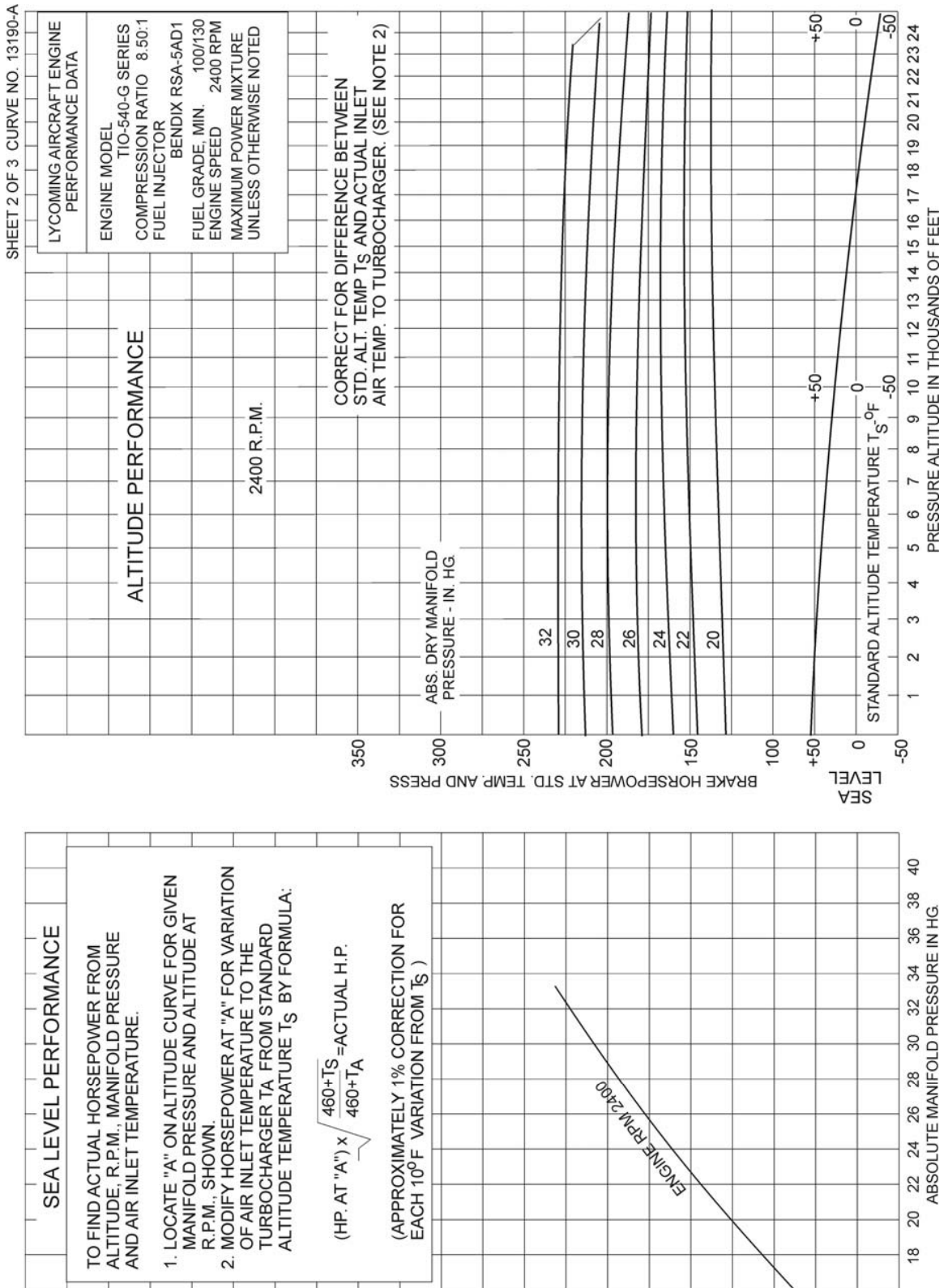

Figure 3-13. Sea Level/Altitude Performance Curve – TIO-540-G1A (Sheet 2 of 3)

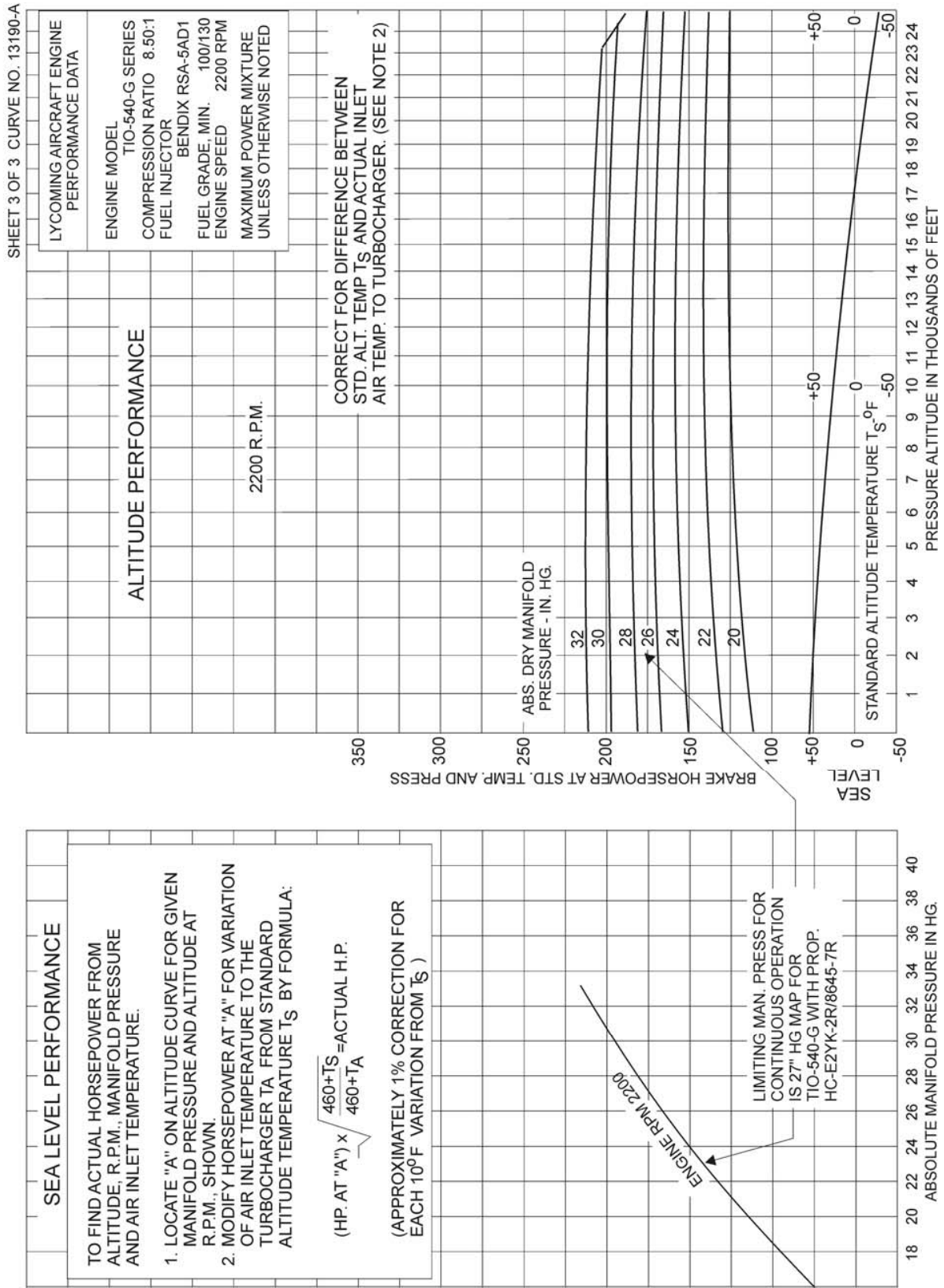

Figure 3-14. Sea Level/Altitude Performance Curve – TIO-540-G1A (Sheet 3 of 3)

FUEL FLOW vs PERCENT RATED POWER

LYCOMING MODEL	TIO-540-H SERIES
COMPRESSION RATIO	7:20:1
SPARK ADVANCE	20° BTC
FUEL INJECTOR	BENDIX RSA-5AD1
TURBOCHARGER	AIR RESEARCH TE0659
FUEL GRADE, MINIMUM	100/130
MIXTURE CONTROL	MANUAL TO FLOWMETER GAGE

CURVE NO.13207

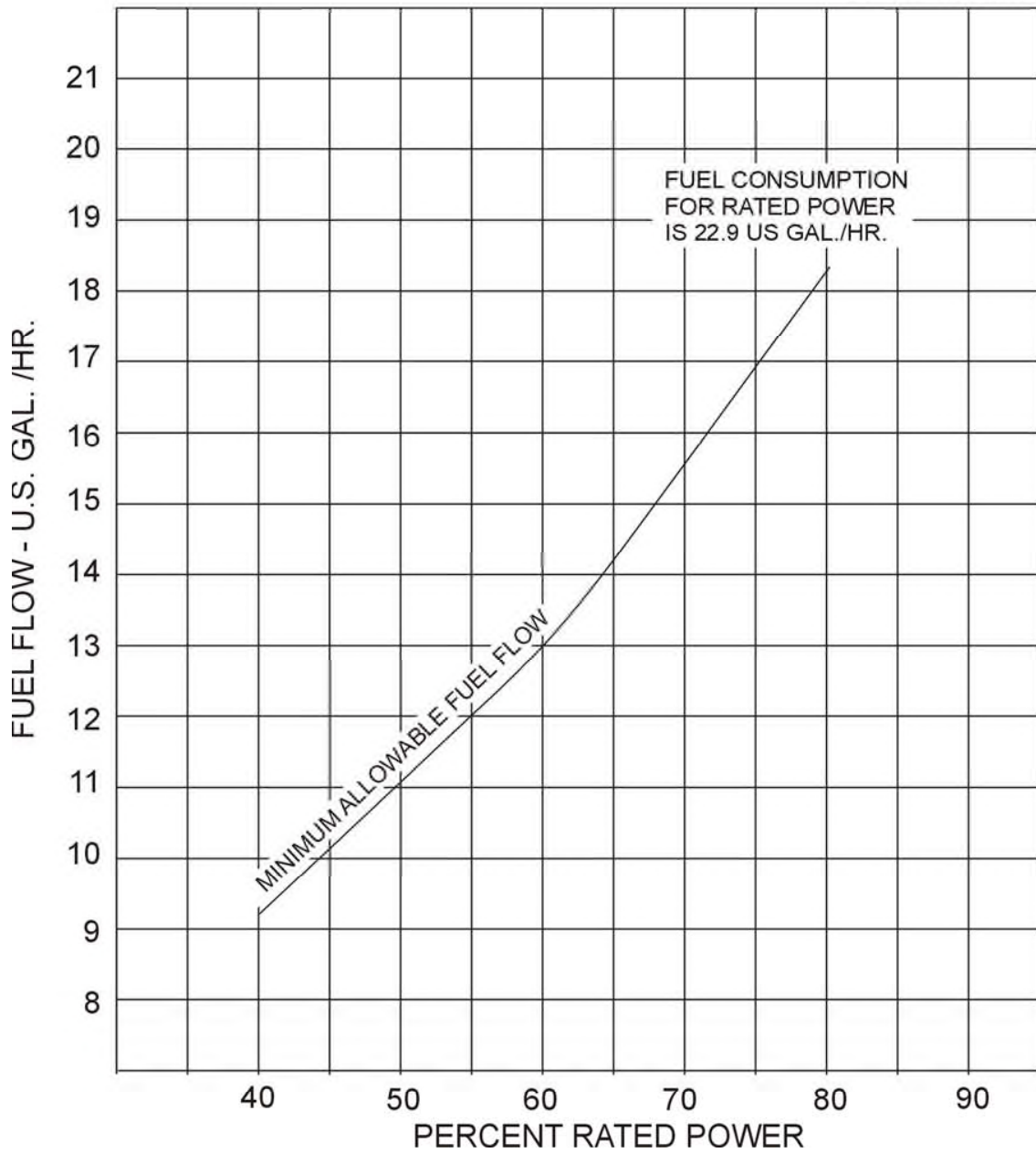

Figure 3-15. Fuel Flow vs Percent Rated Power – TIO-540-H1A

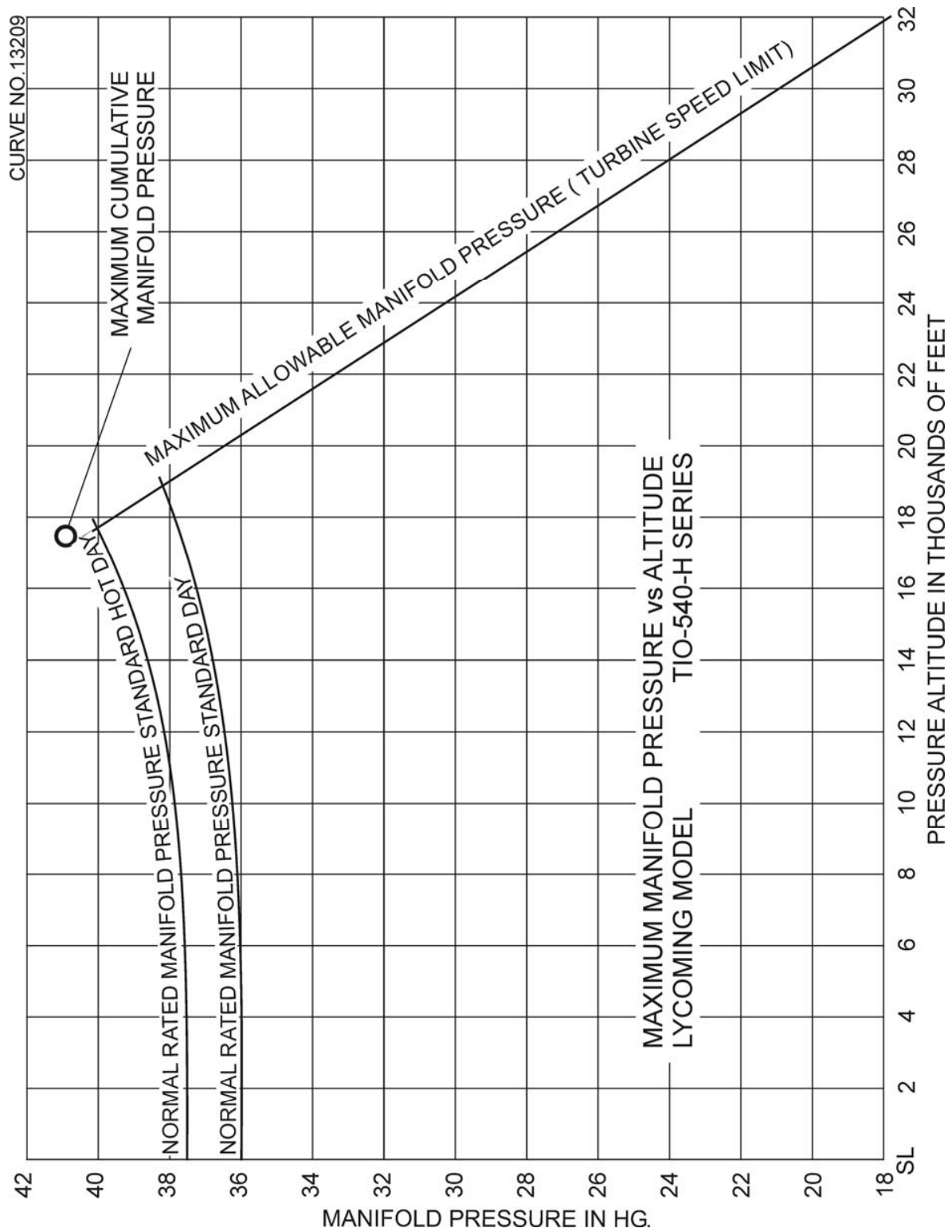

Figure 3-16. Maximum Manifold Pressure vs Altitude – TIO-540-H1A

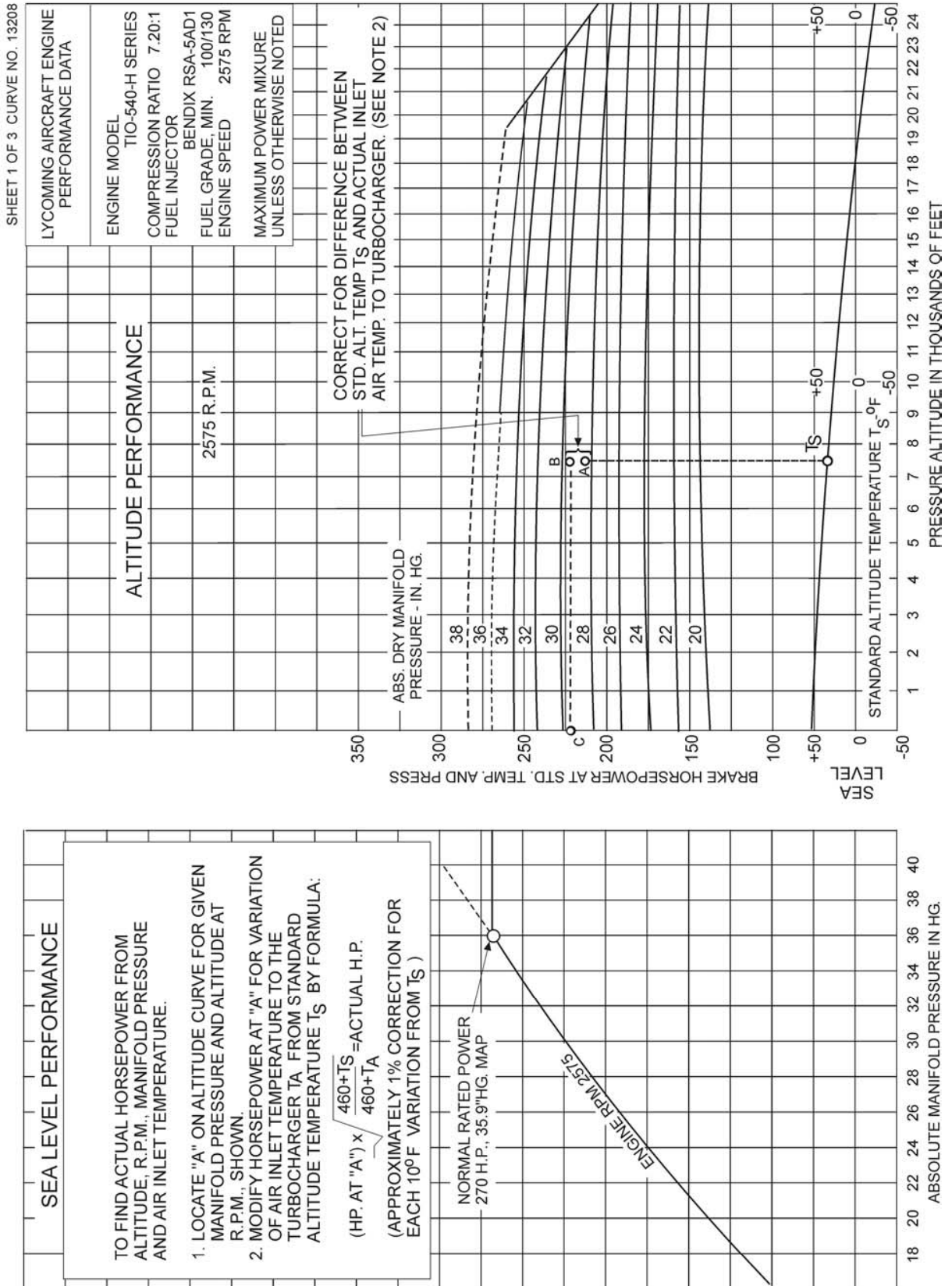

Figure 3-17. Sea Level/Altitude Performance Curve – TIO-540-H1A (Sheet 1 of 3)

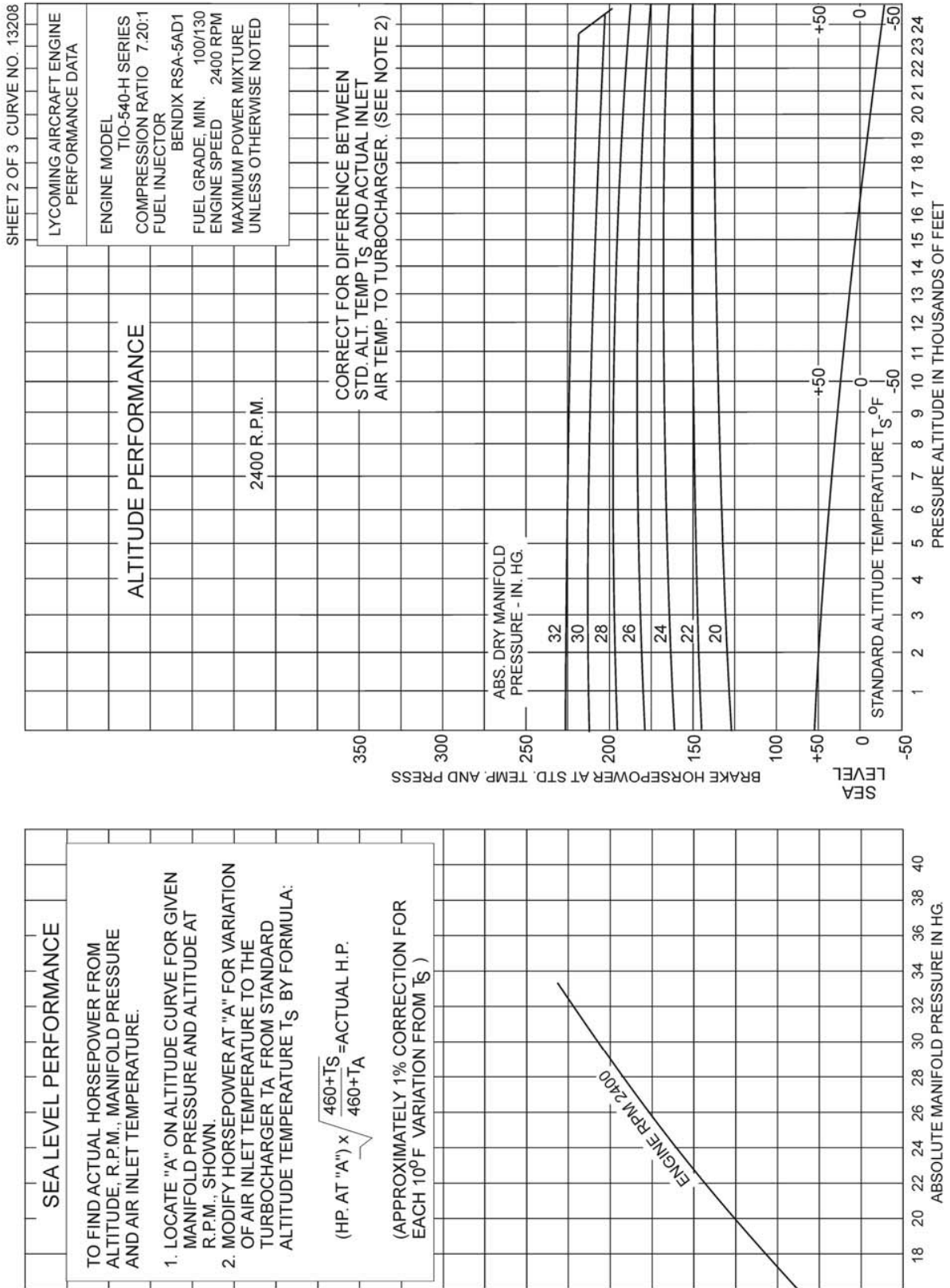

Figure 3-18. Sea Level/Altitude Performance Curve – TIO-540-H1A (Sheet 2 of 3)

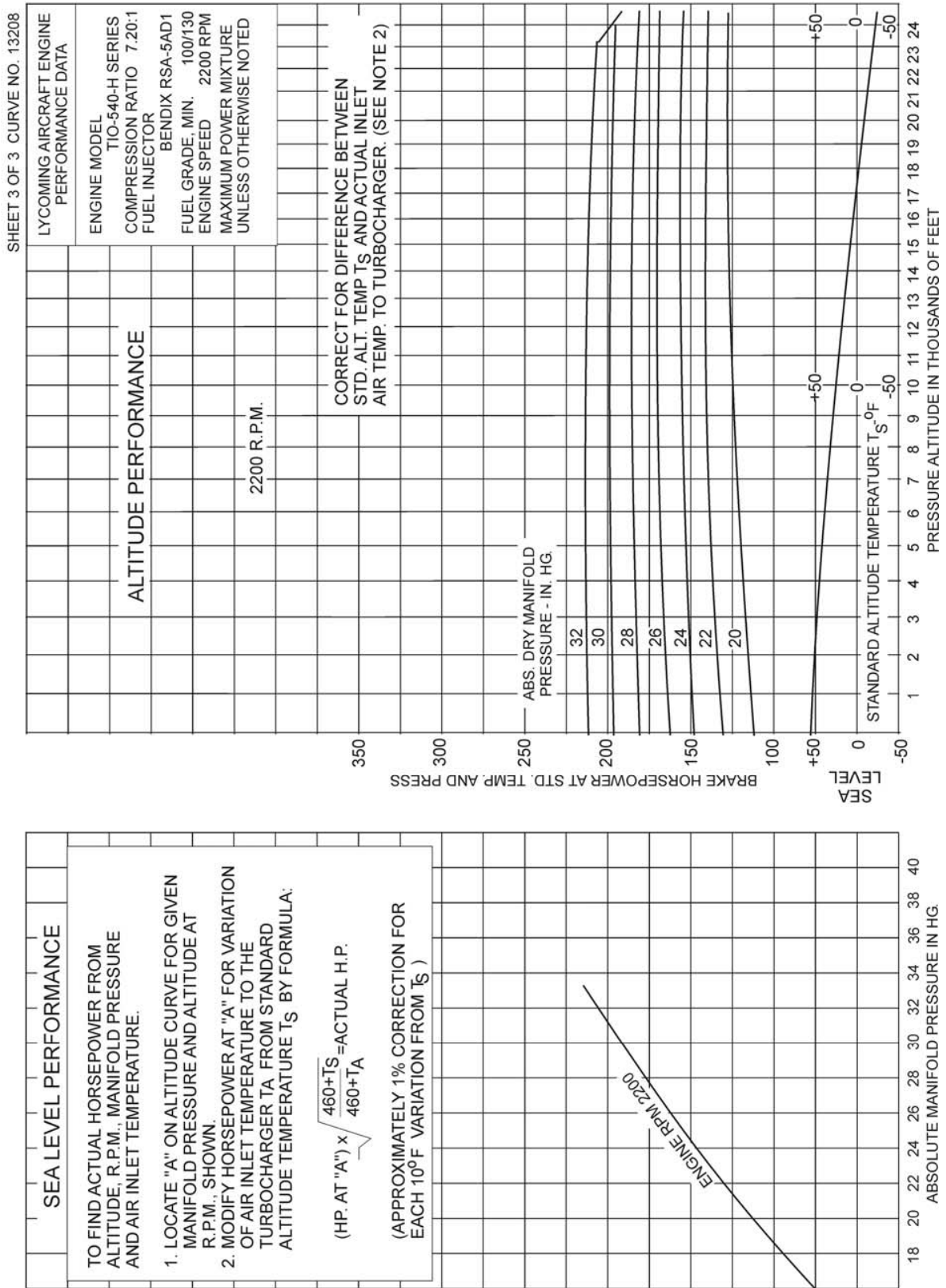

Figure 3-19. Sea Level/Altitude Performance Curve – TIO-540-H1A (Sheet 3 of 3)

CURVE NO.13477

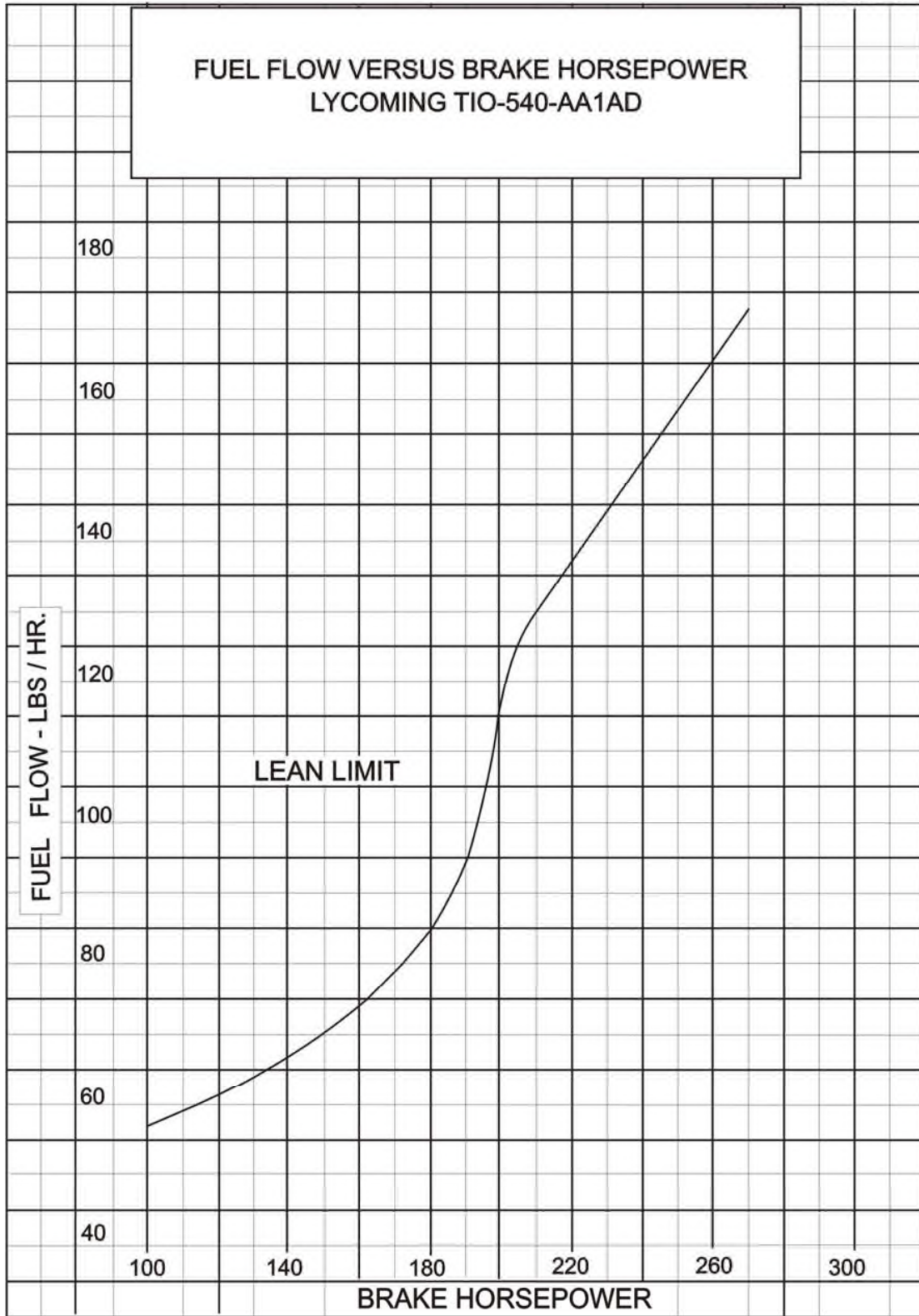

Figure 3-20. Fuel Flow vs Brake Horsepower – TIO-540-AA1AD



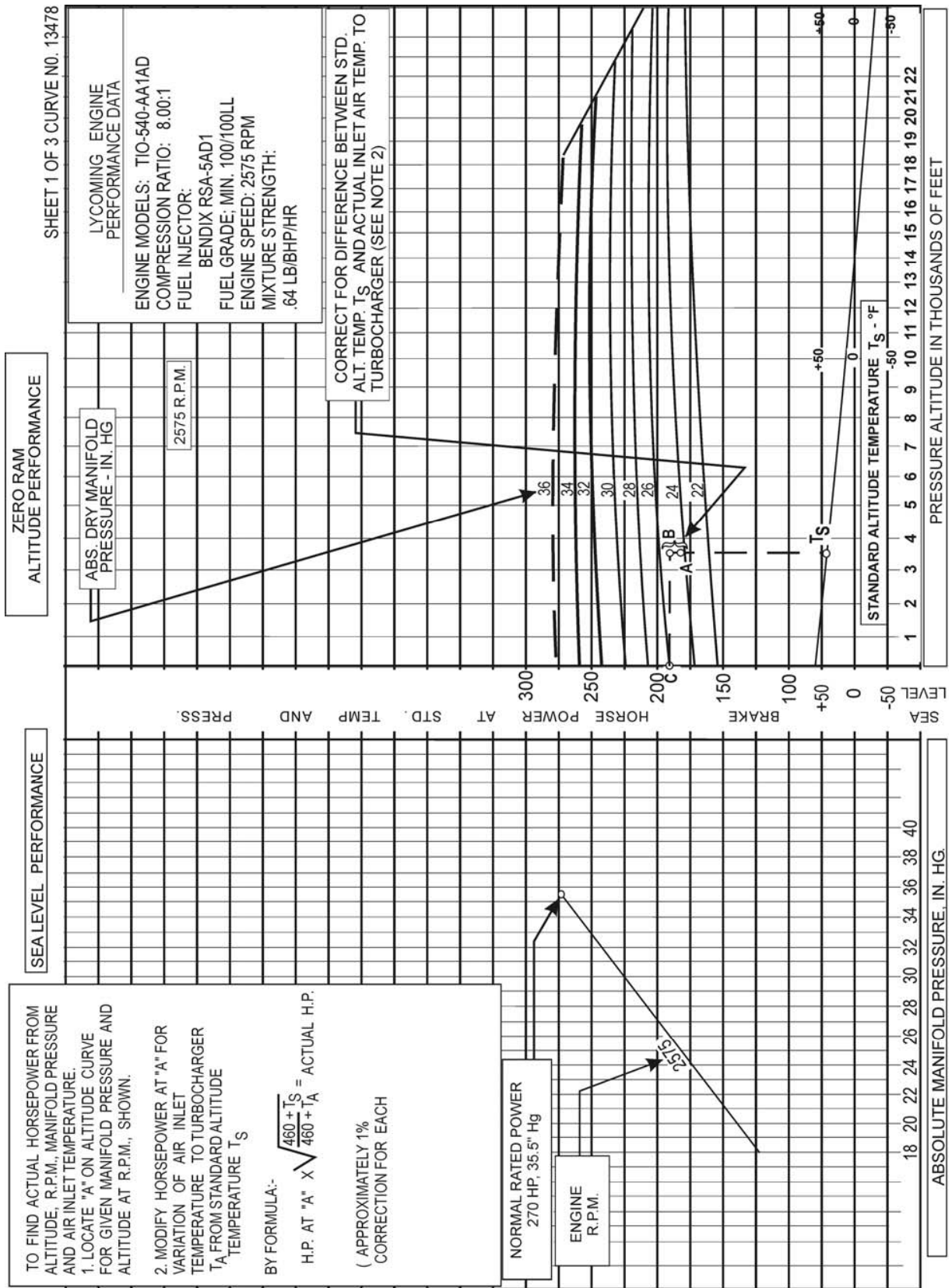

Figure 3-21. Sea Level/Altitude Performance Curve – TIO-540-AA1AD (Sheet 1 of 3)

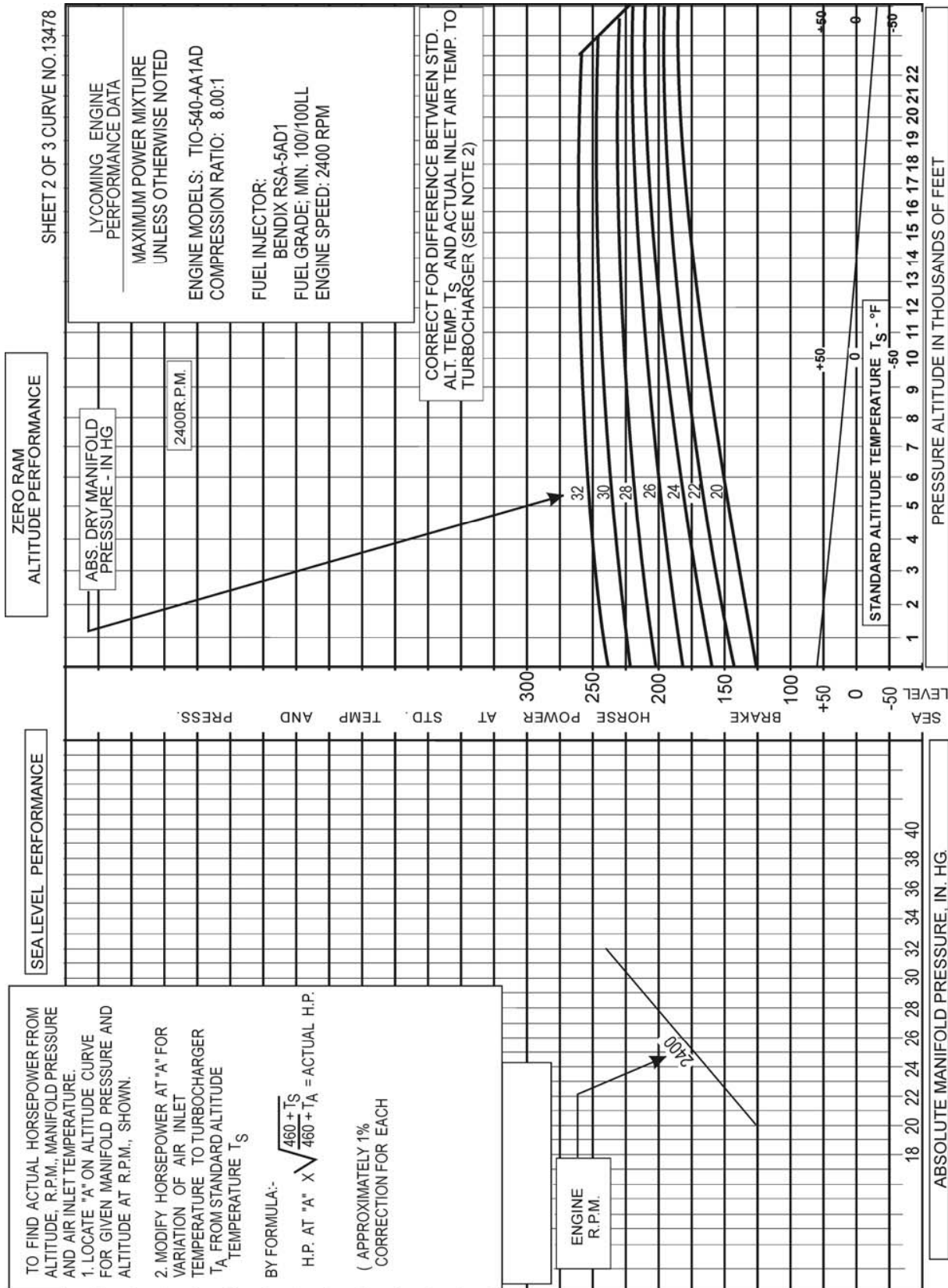

Figure 3-22. Sea Level/Altitude Performance Curve – TIO-540-AA1AD (Sheet 2 of 3)

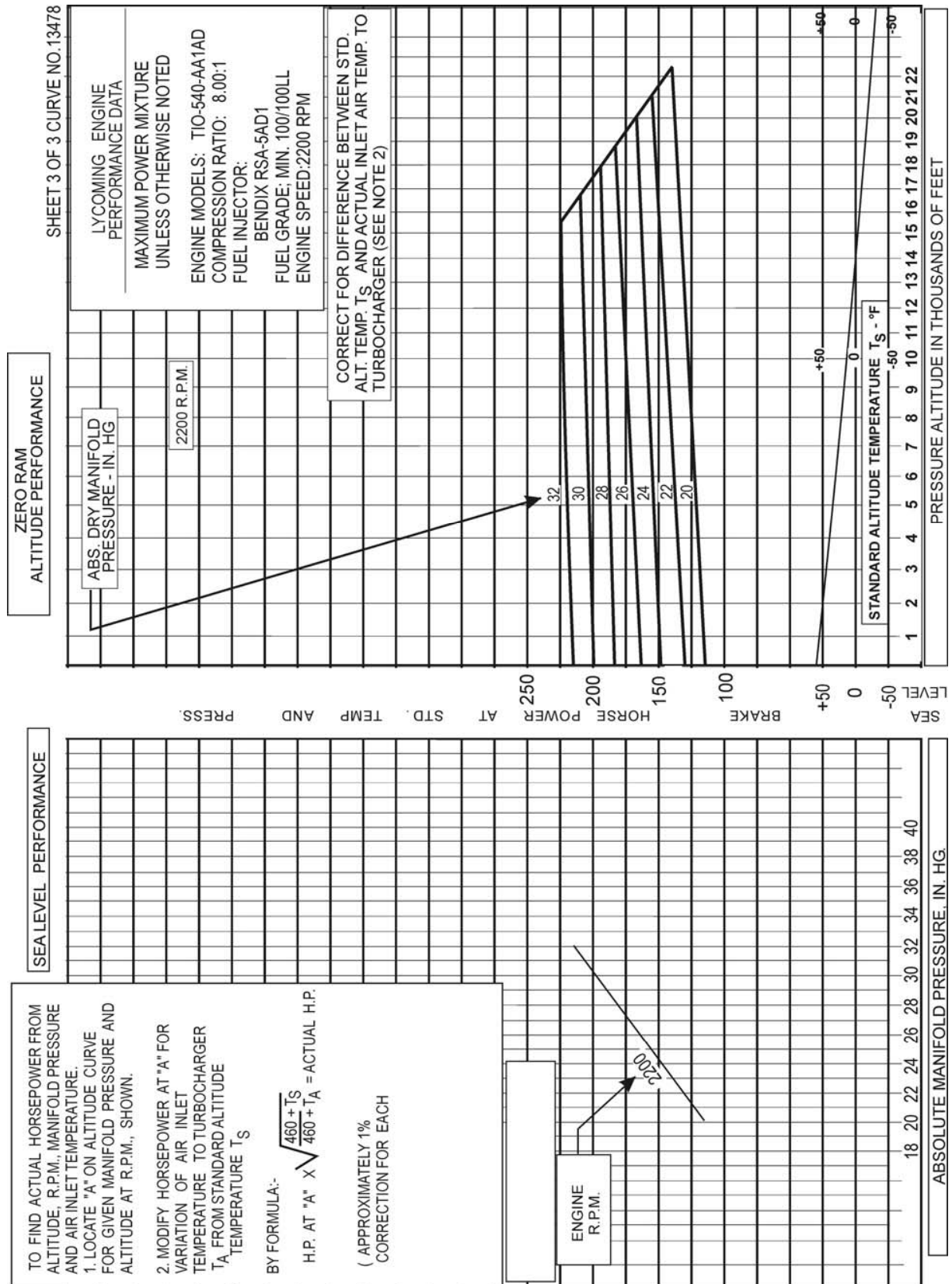

Figure 3-23. Sea Level/Altitude Performance Curve – TIO-540-AA1AD (Sheet 3 of 3)

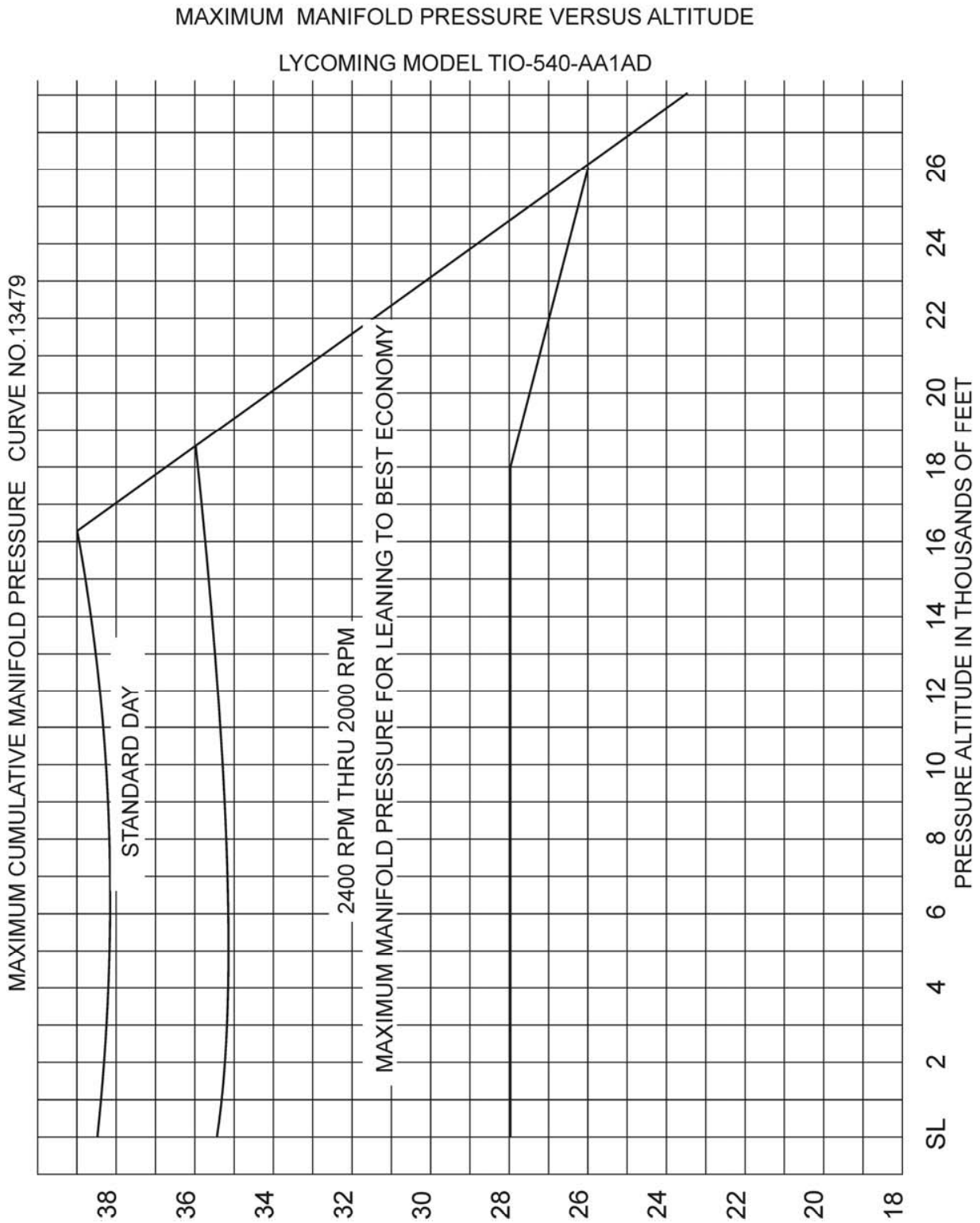

Figure 3-24. Maximum Manifold Pressure vs Altitude – TIO-540-AA1AD

CURVE NO.13454

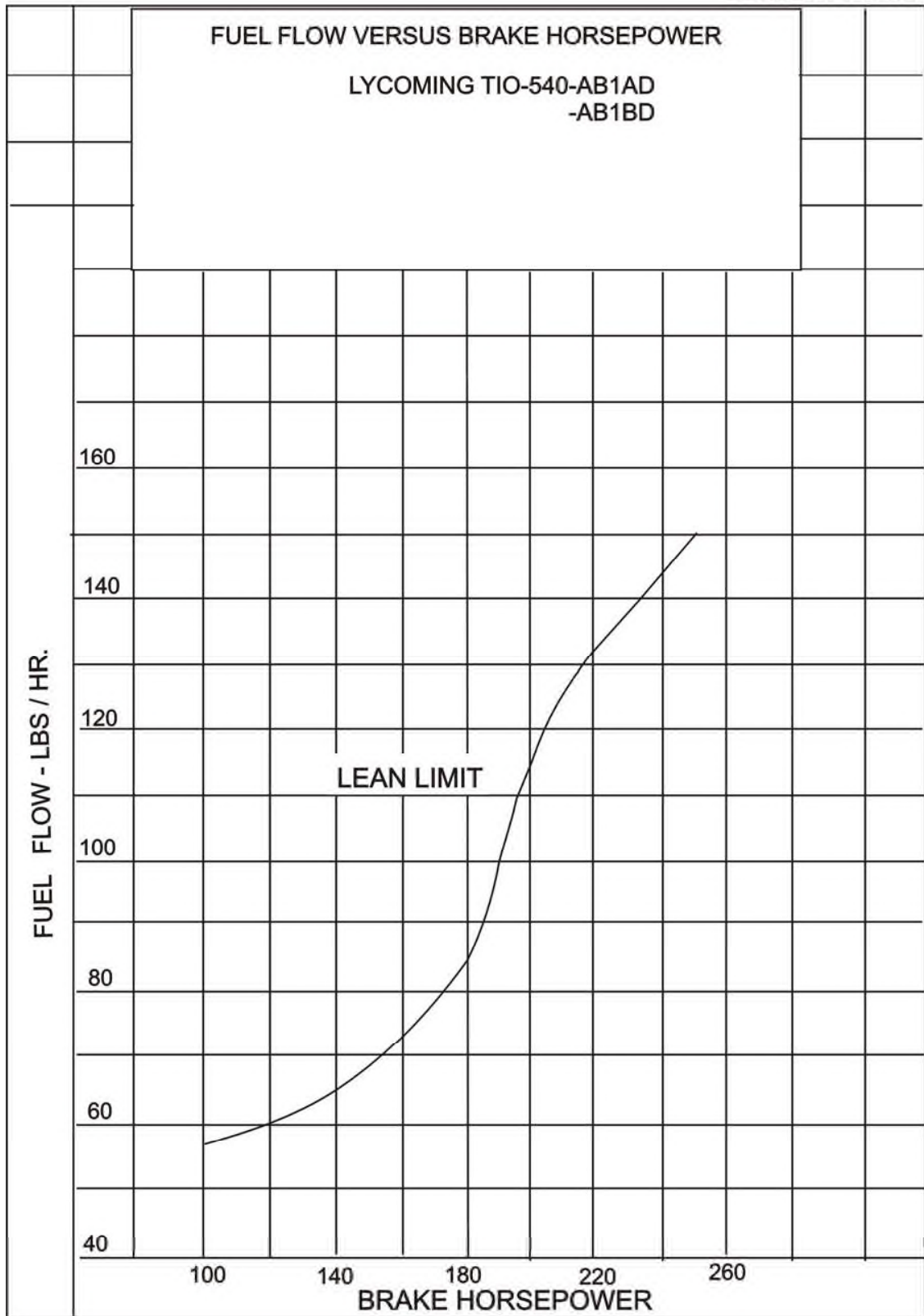

Figure 3-25. Fuel Flow vs Brake Horsepower – TIO-540-AB1AD, -AB1BD

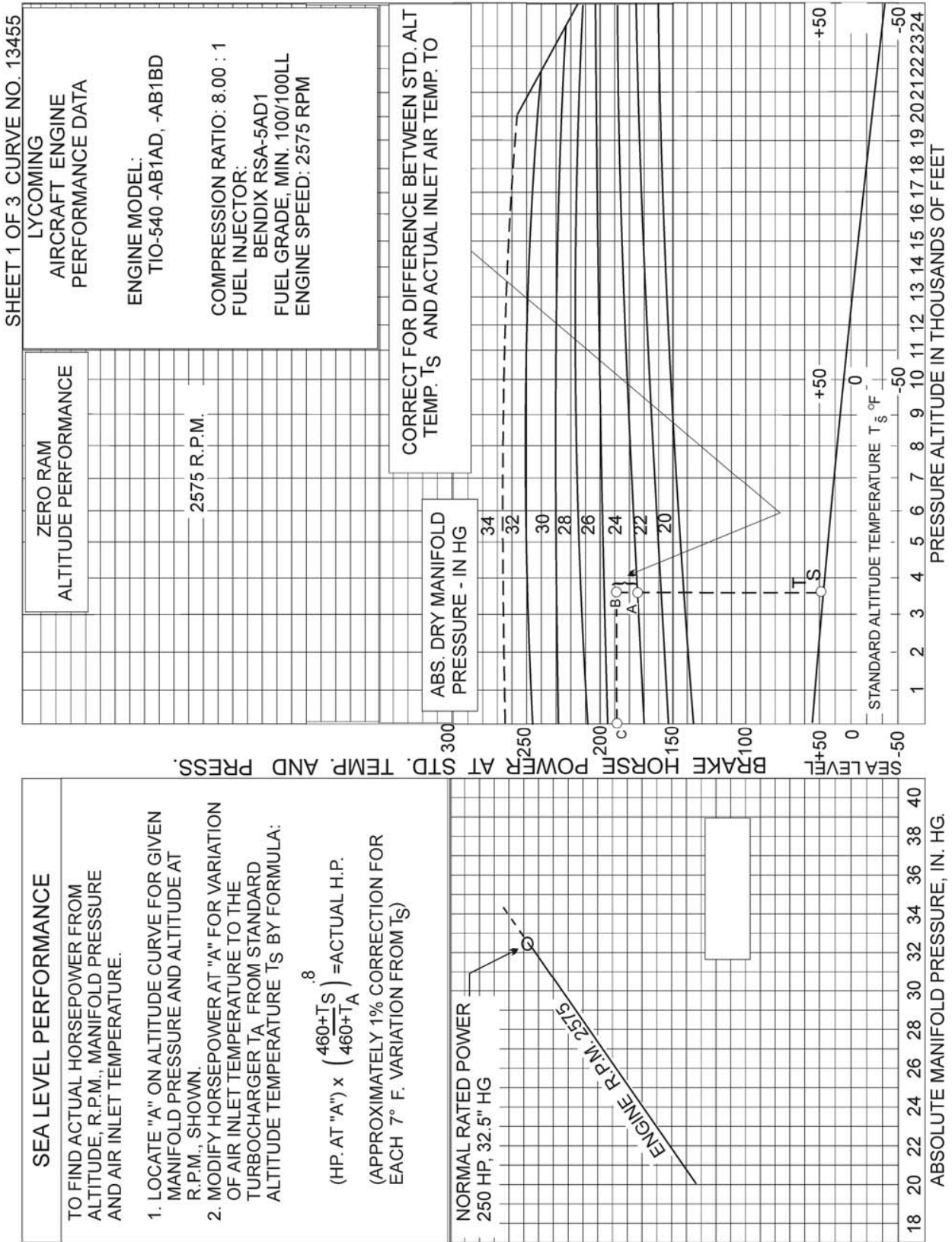

Figure 3-26. Sea Level/Altitude Performance Curve – TIO-540-AB1AD, -AB1BD (Sheet 1 of 3)

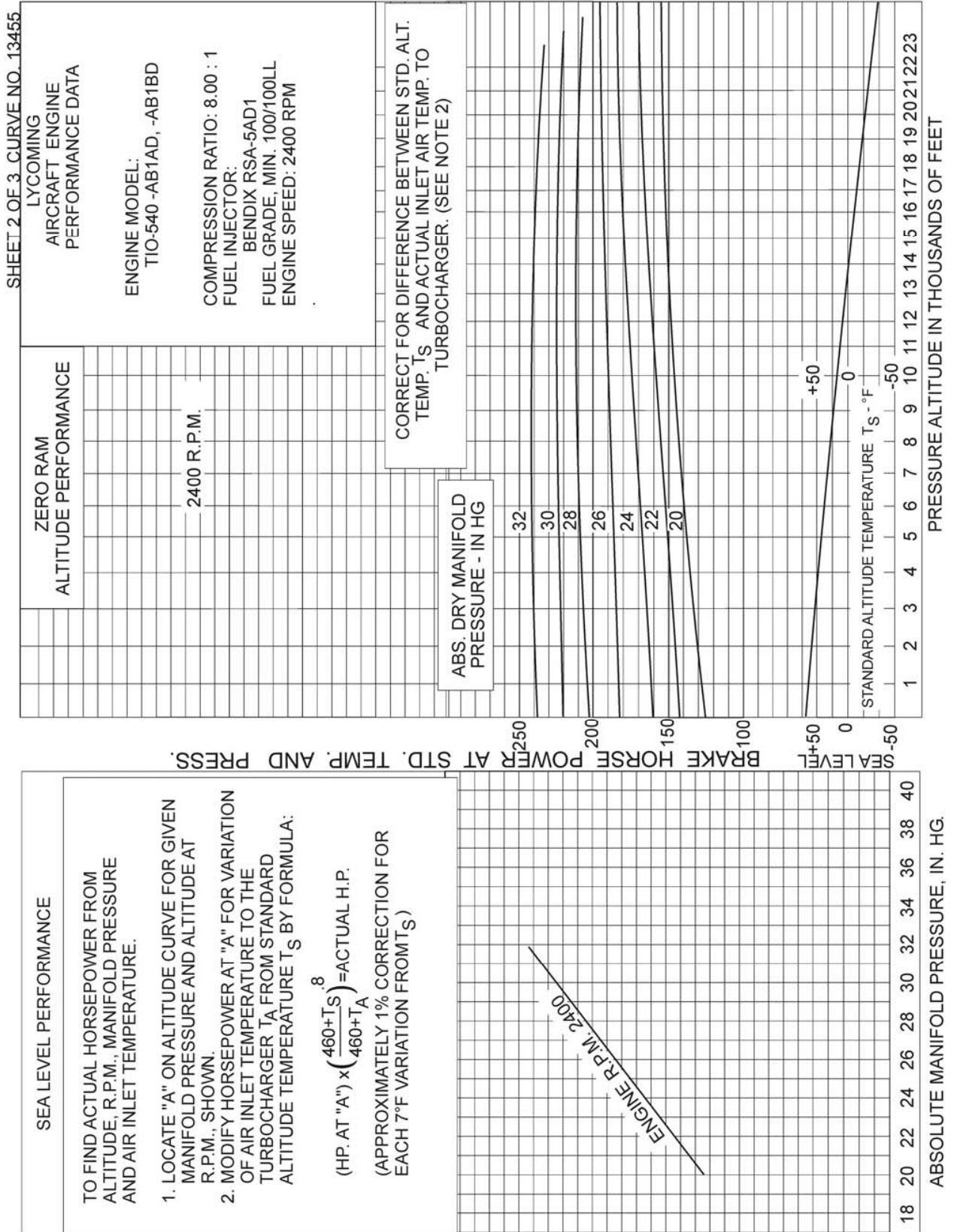

Figure 3-27. Sea Level/Altitude Performance Curve – TIO-540-AB1AD, -AB1BD (Sheet 2 of 3)

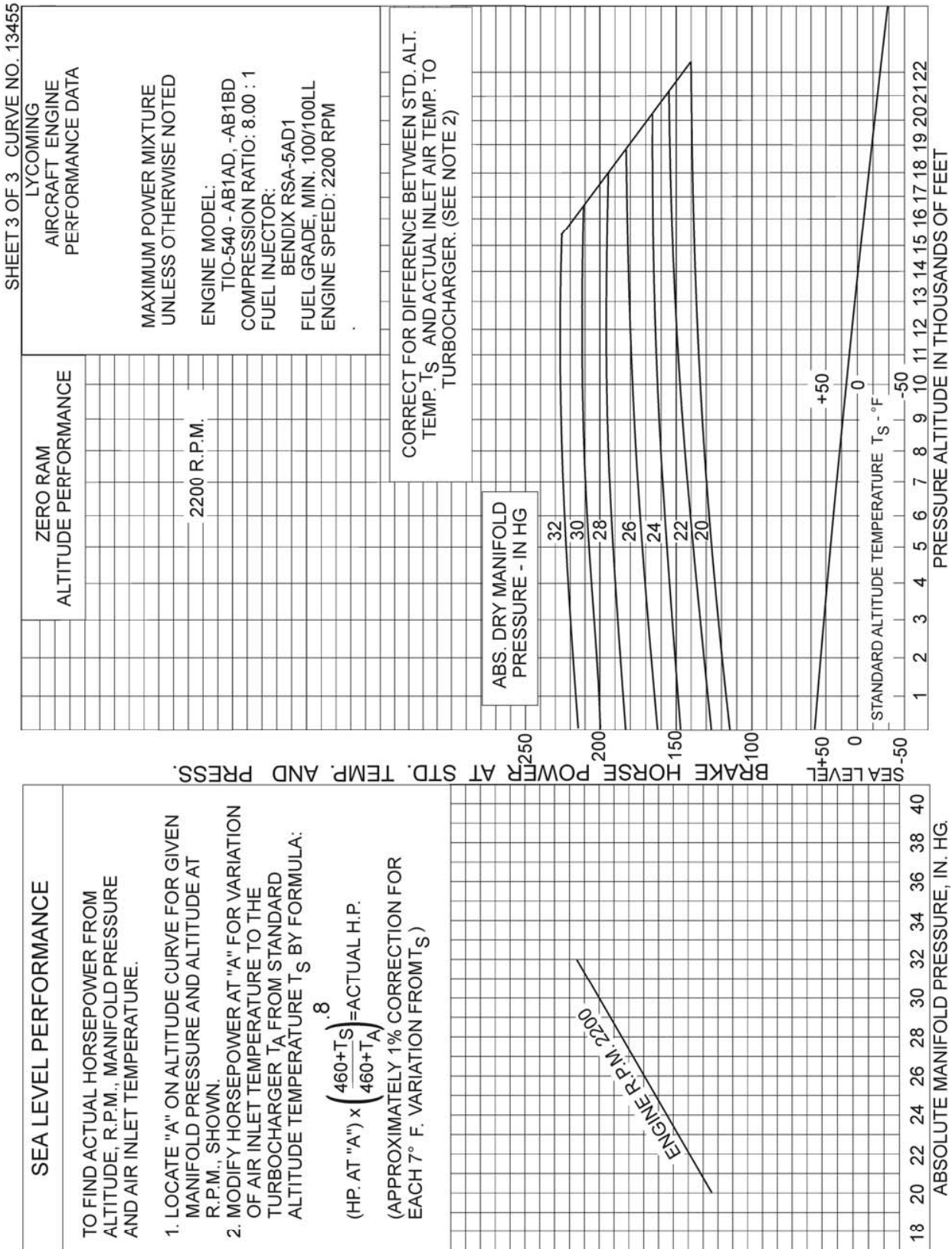

Figure 3-28. Sea Level/Altitude Performance Curve – TIO-540-AB1AD, -AB1BD (Sheet 3 of 3)



CURVE NO.13456-B

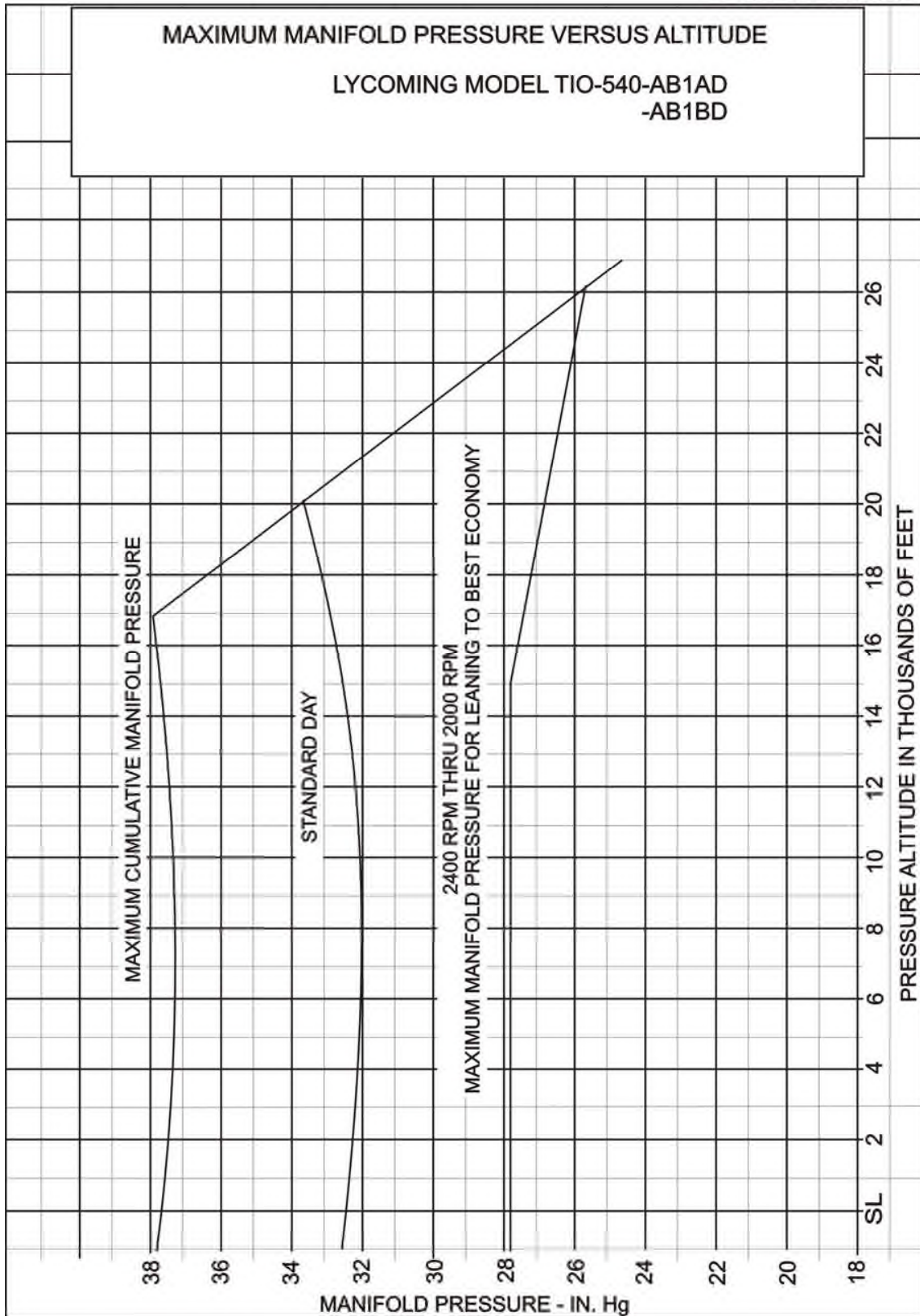

Figure 3-29. Maximum Manifold Pressure vs Altitude – TIO-540-AB1AD, -AB1BD

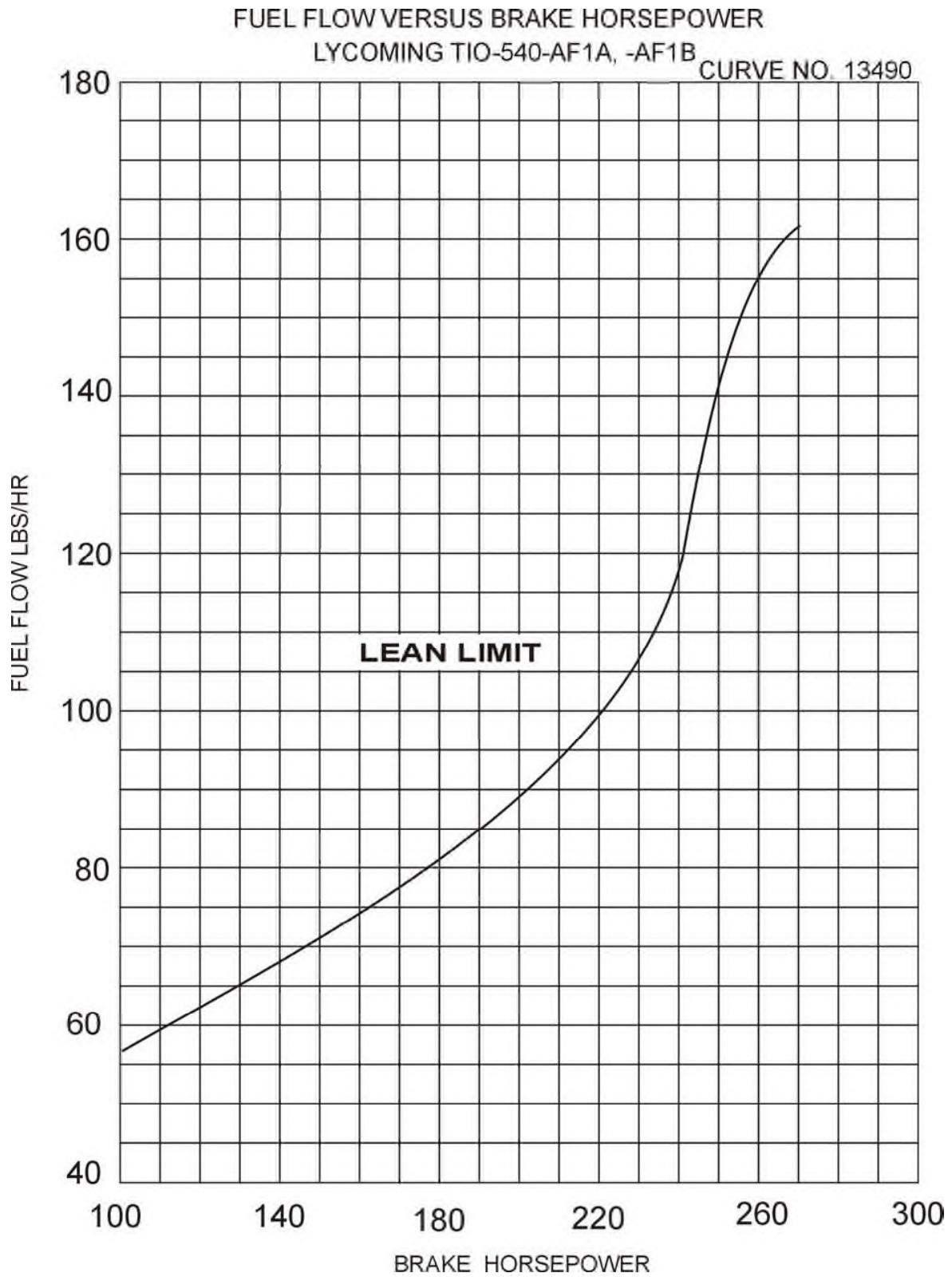

Figure 3-30. Fuel Flow vs Brake Horsepower – TIO-540-AF1A, -AF1B

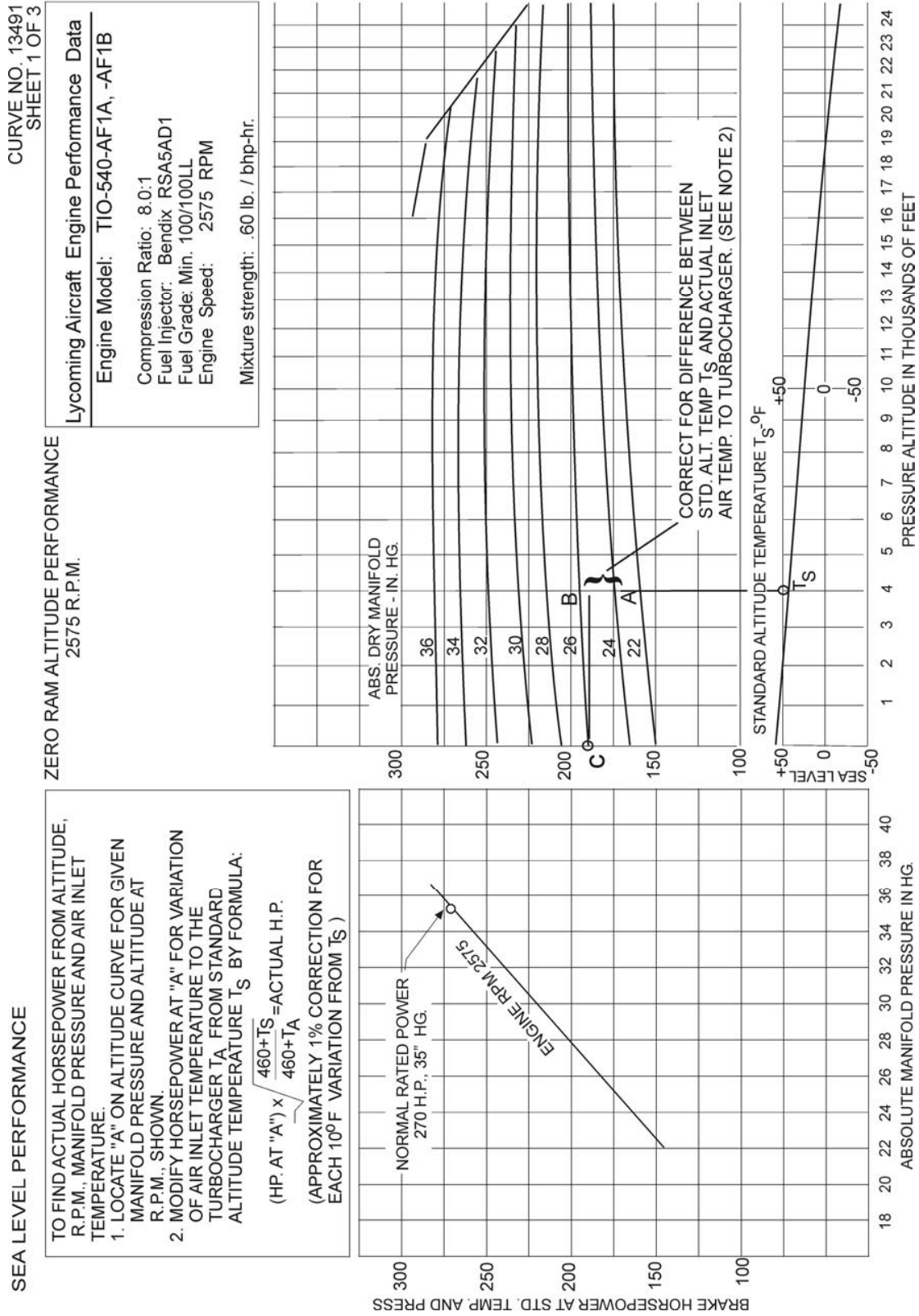

Figure 3-31. Sea Level/Altitude Performance Curve – TIO-540-AF1A, -AF1B (Sheet 1 of 3)

**SECTION 3  
OPERATING INSTRUCTIONS**

**LYCOMING OPERATOR'S MANUAL  
TIO-540 SERIES – PARALLEL VALVE CYLINDER HEADS**

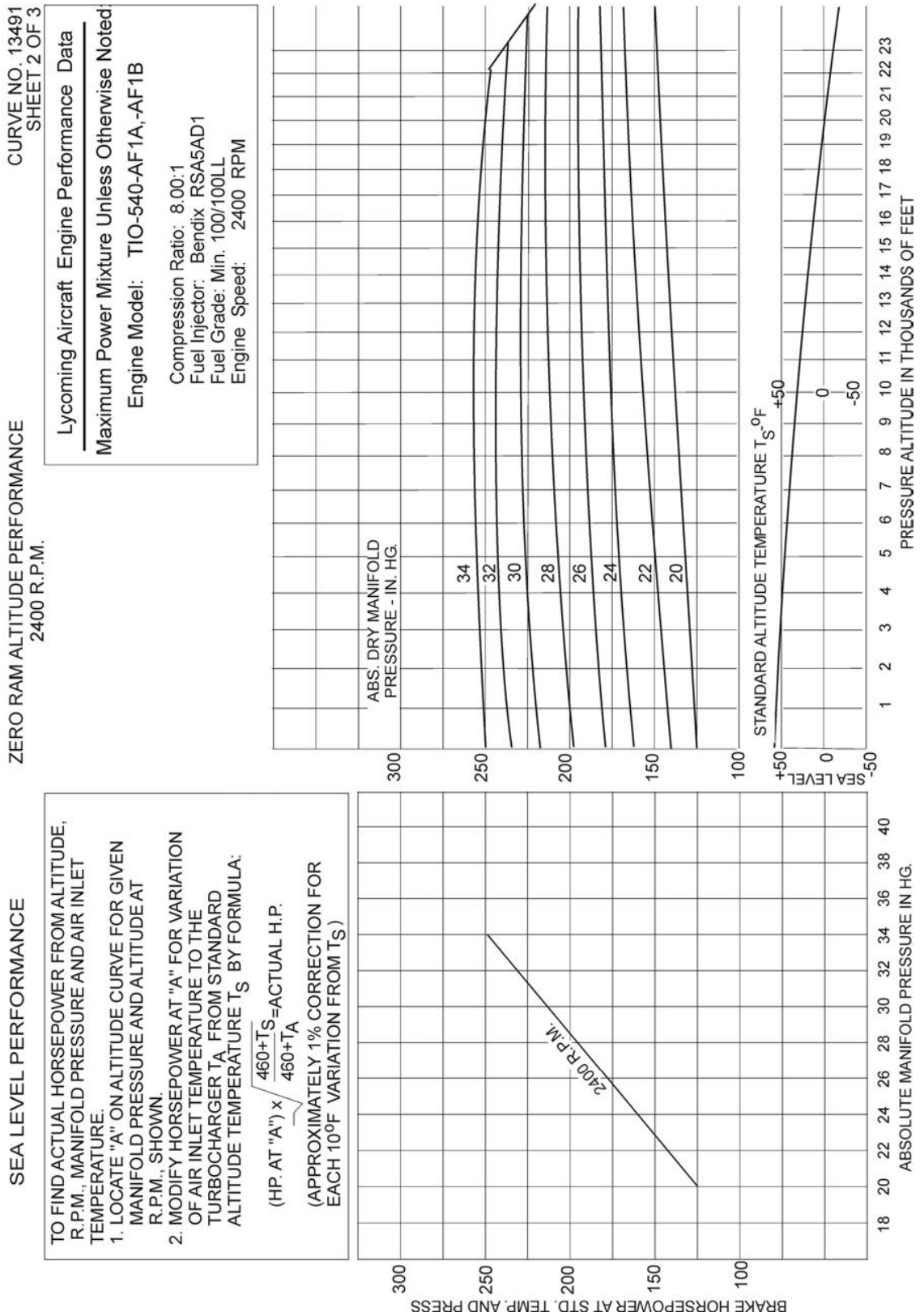

Figure 3-32. Sea Level/Altitude Performance Curve – TIO-540-AF1A, -AF1B (Sheet 2 of 3)

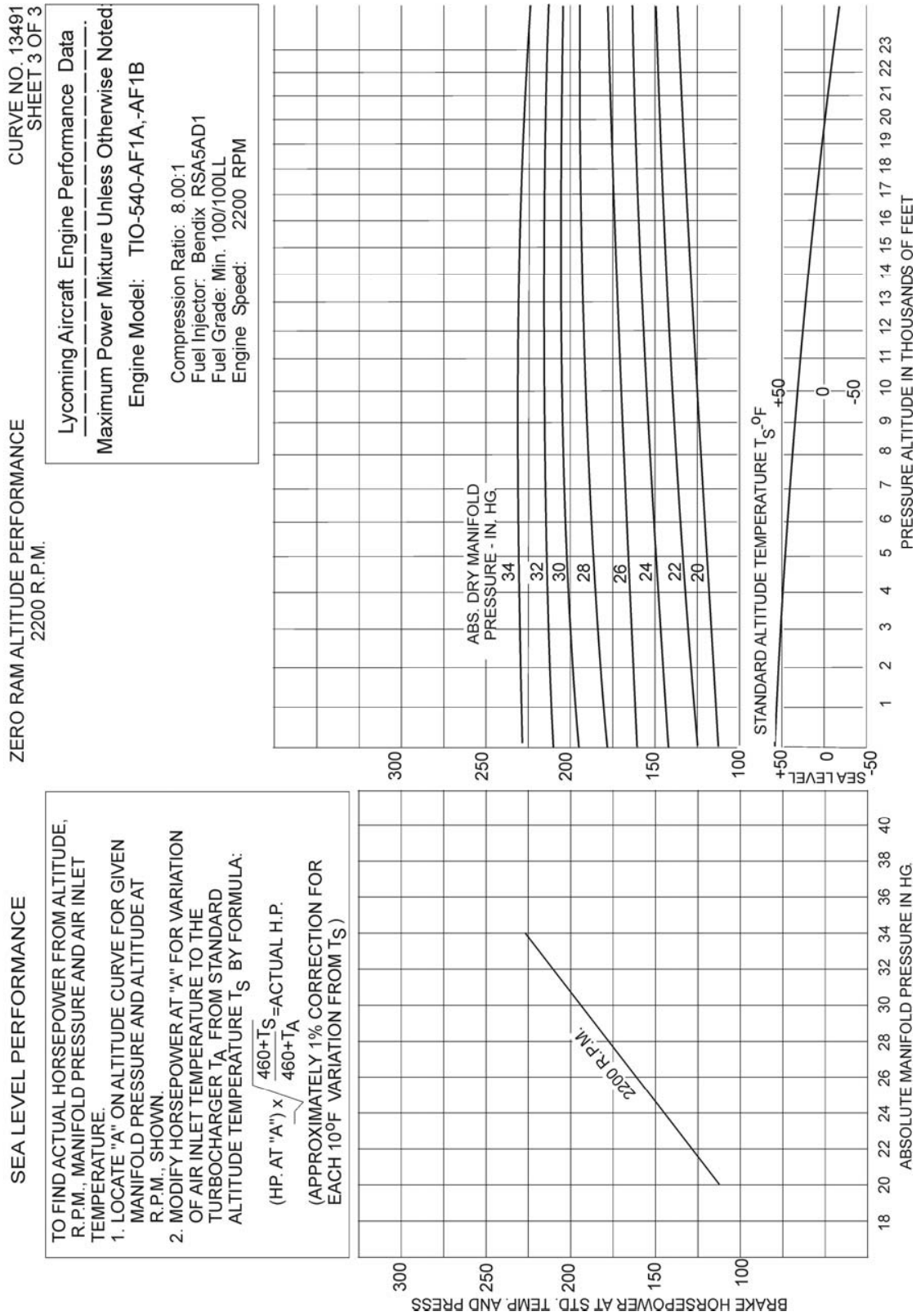

Figure 3-33. Sea Level/Altitude Performance Curve – TIO-540-AF1A, -AF1B (Sheet 3 of 3)

MAXIMUM MANIFOLD PRESSURE VERSUS ALTITUDE  
LYCOMING MODEL TIO-540-AF1A,-AF1B

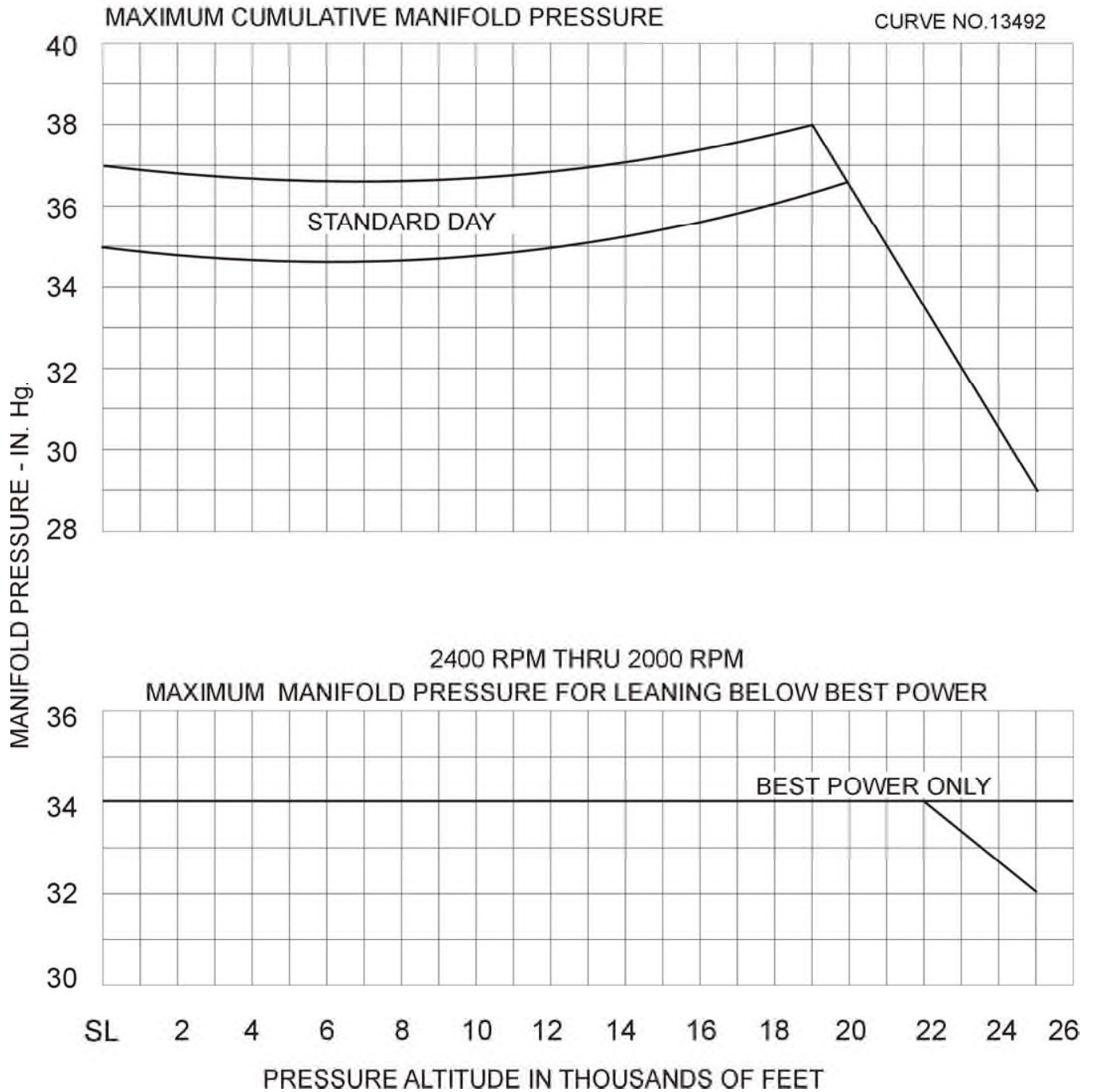

Figure 3-34. Maximum Manifold Pressure vs Altitude – TIO-540-AF1A, -AF1B

CURVE NO.13477

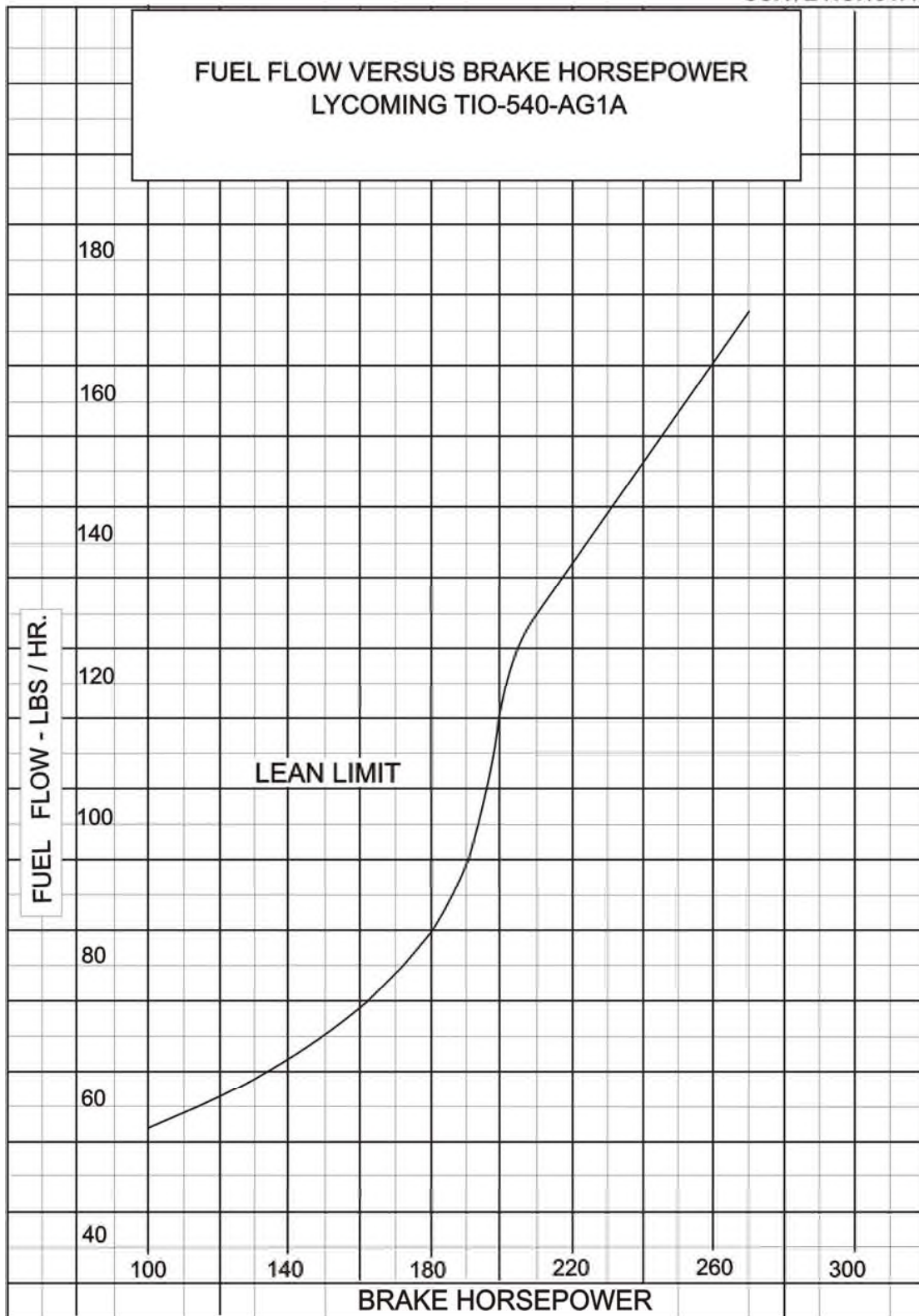

Figure 3-35. Fuel Flow vs Brake Horsepower – TIO-540-AG1A

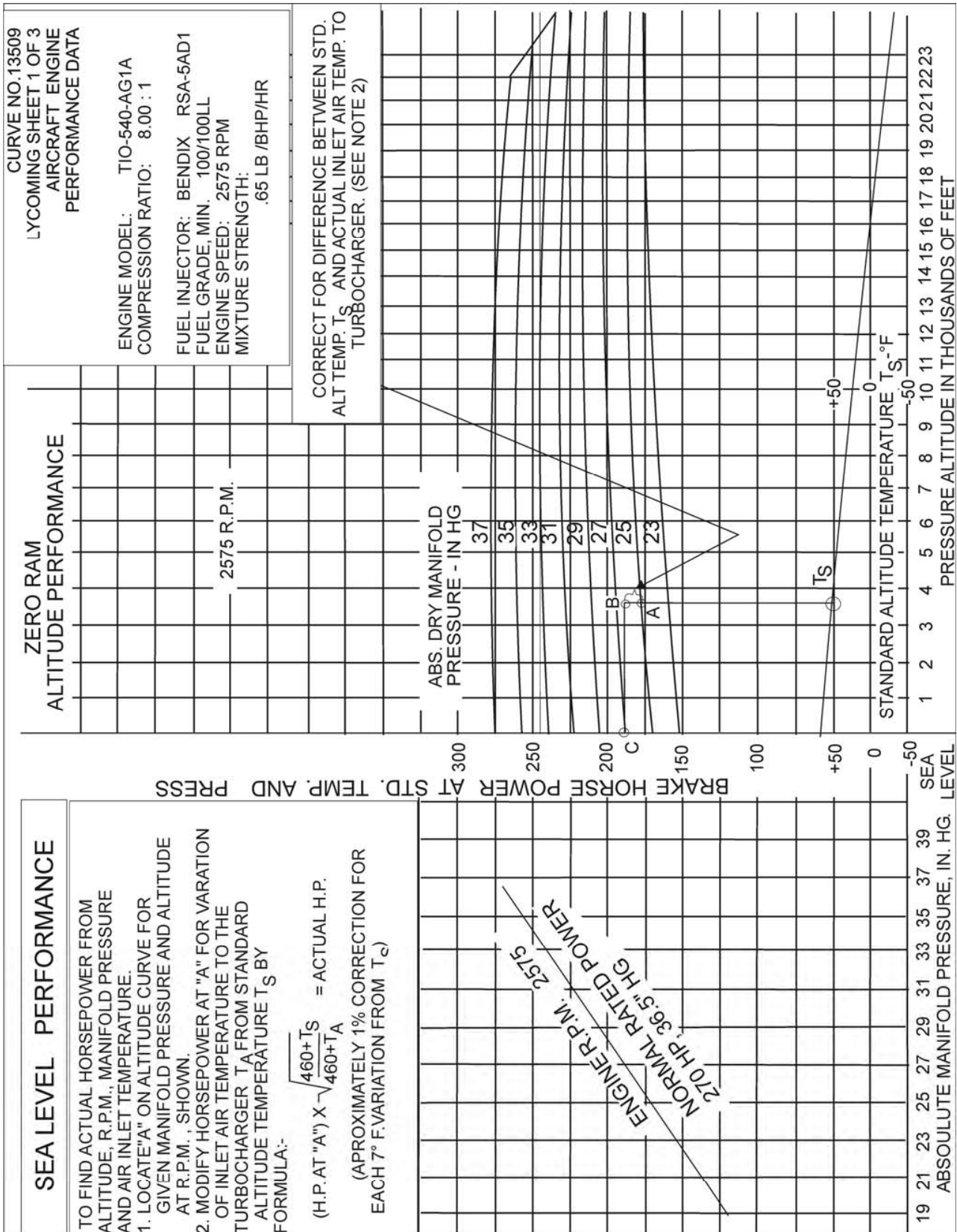

Figure 3-36. Sea Level/Altitude Performance Curve – TIO-540-AG1A (Sheet 1 of 3)



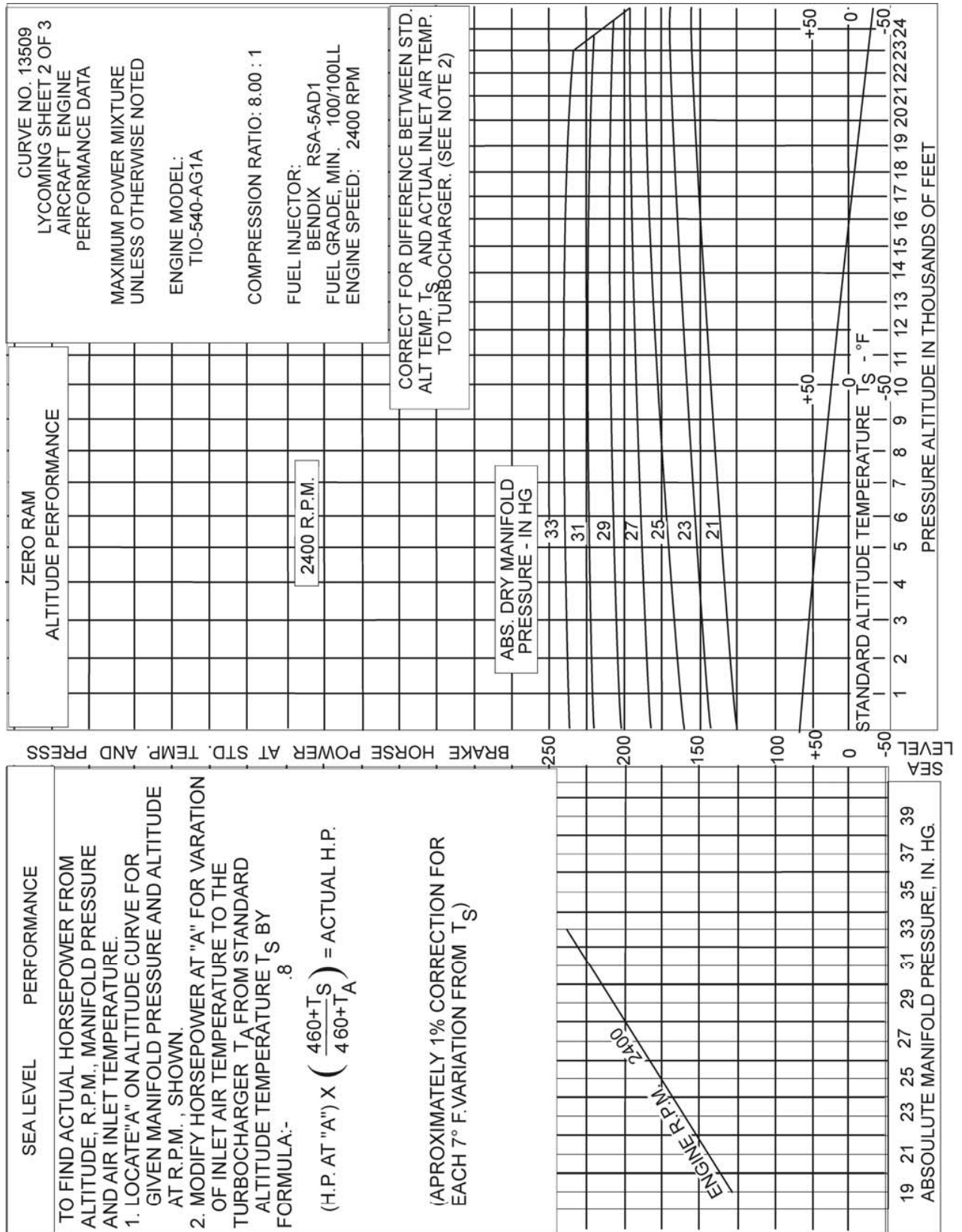

Figure 3-37. Sea Level/Altitude Performance Curve – TIO-540-AG1A (Sheet 2 of 3)

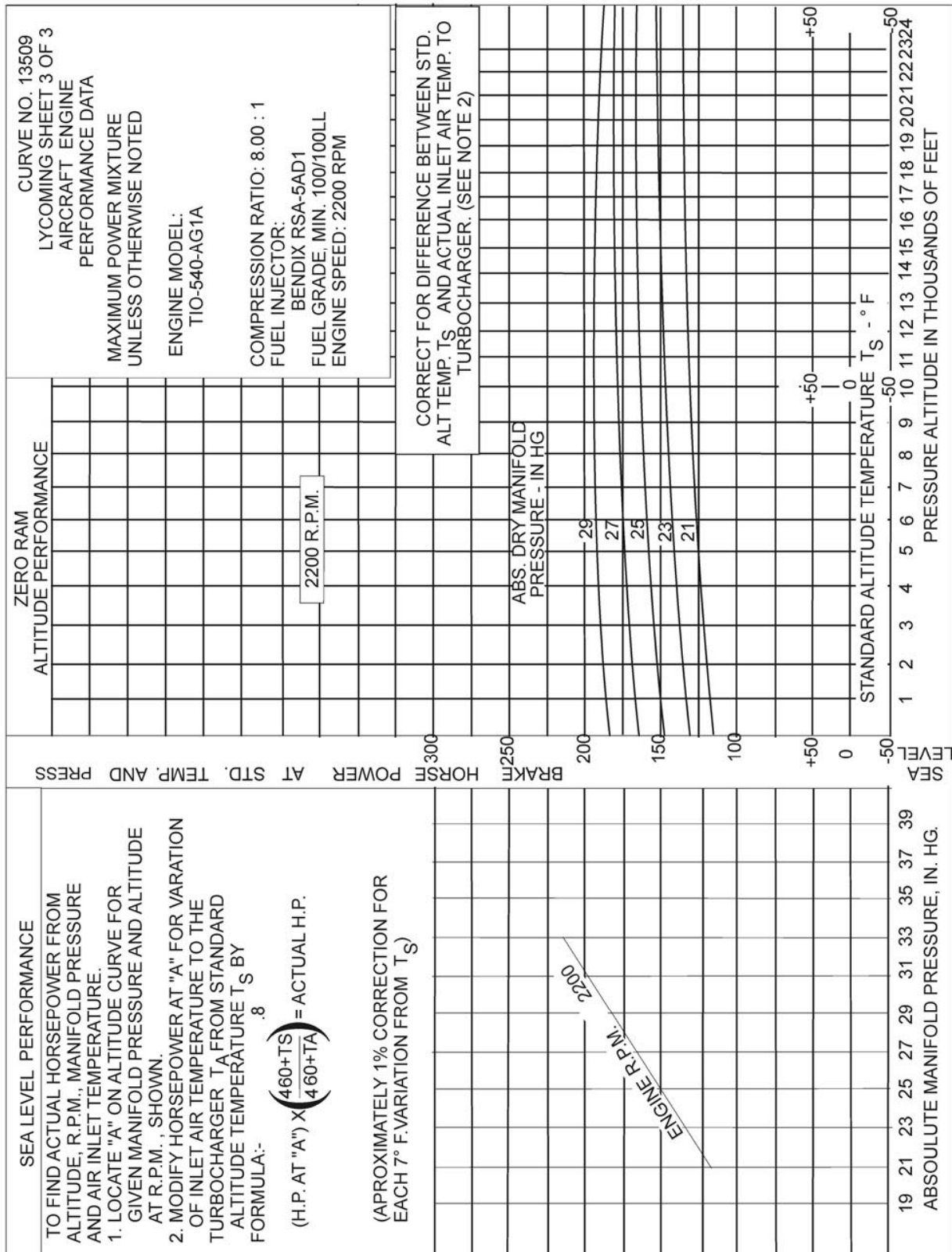

Figure 3-38. Sea Level/Altitude Performance Curve – TIO-540-AG1A (Sheet 3 of 3)

CURVE NO.13510

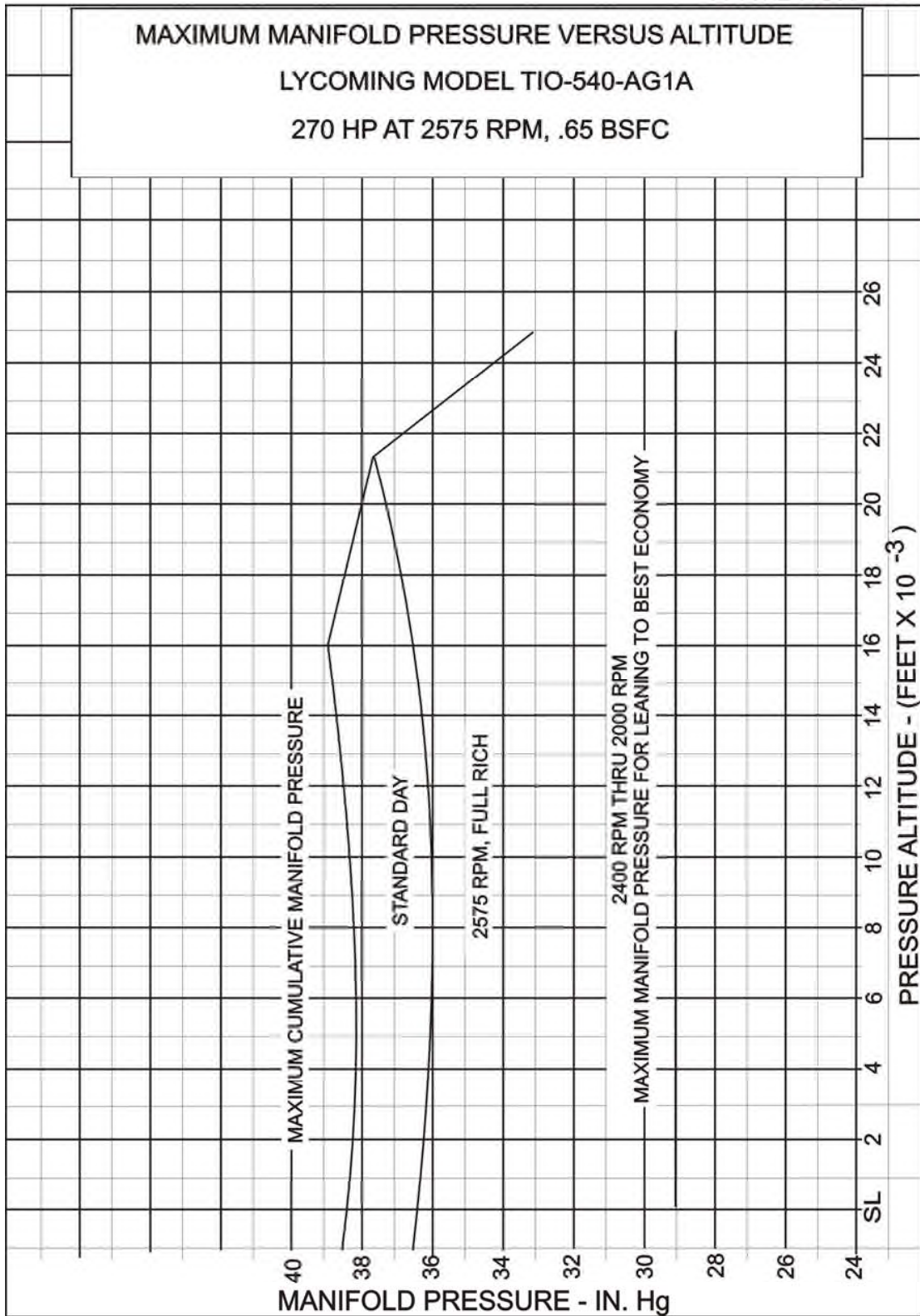

Figure 3-39. Maximum Manifold Pressure vs Altitude – TIO-540-AG1A

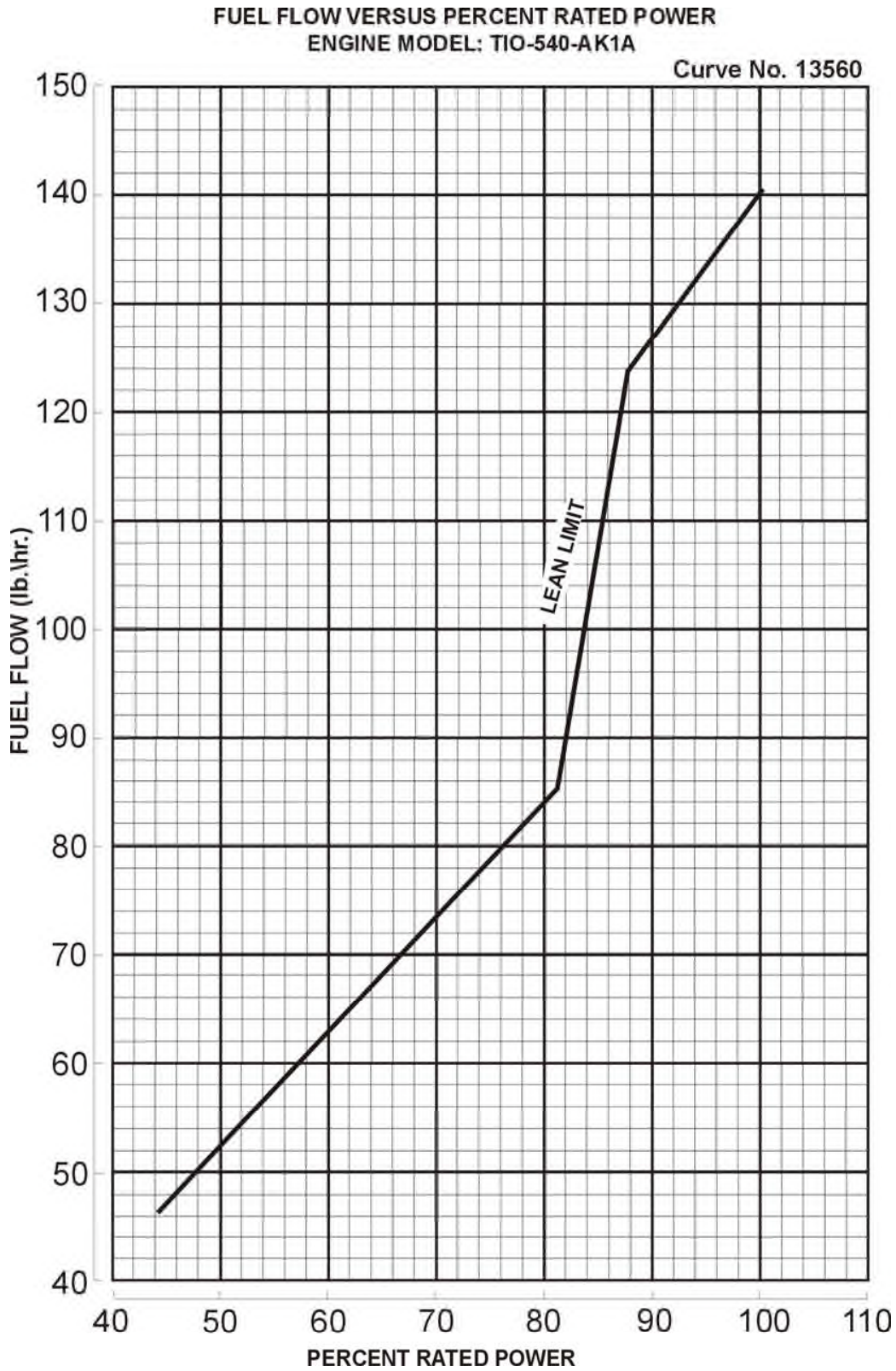

Figure 3-40. Fuel Flow vs Percent Rated Power – TIO-540-AK1A

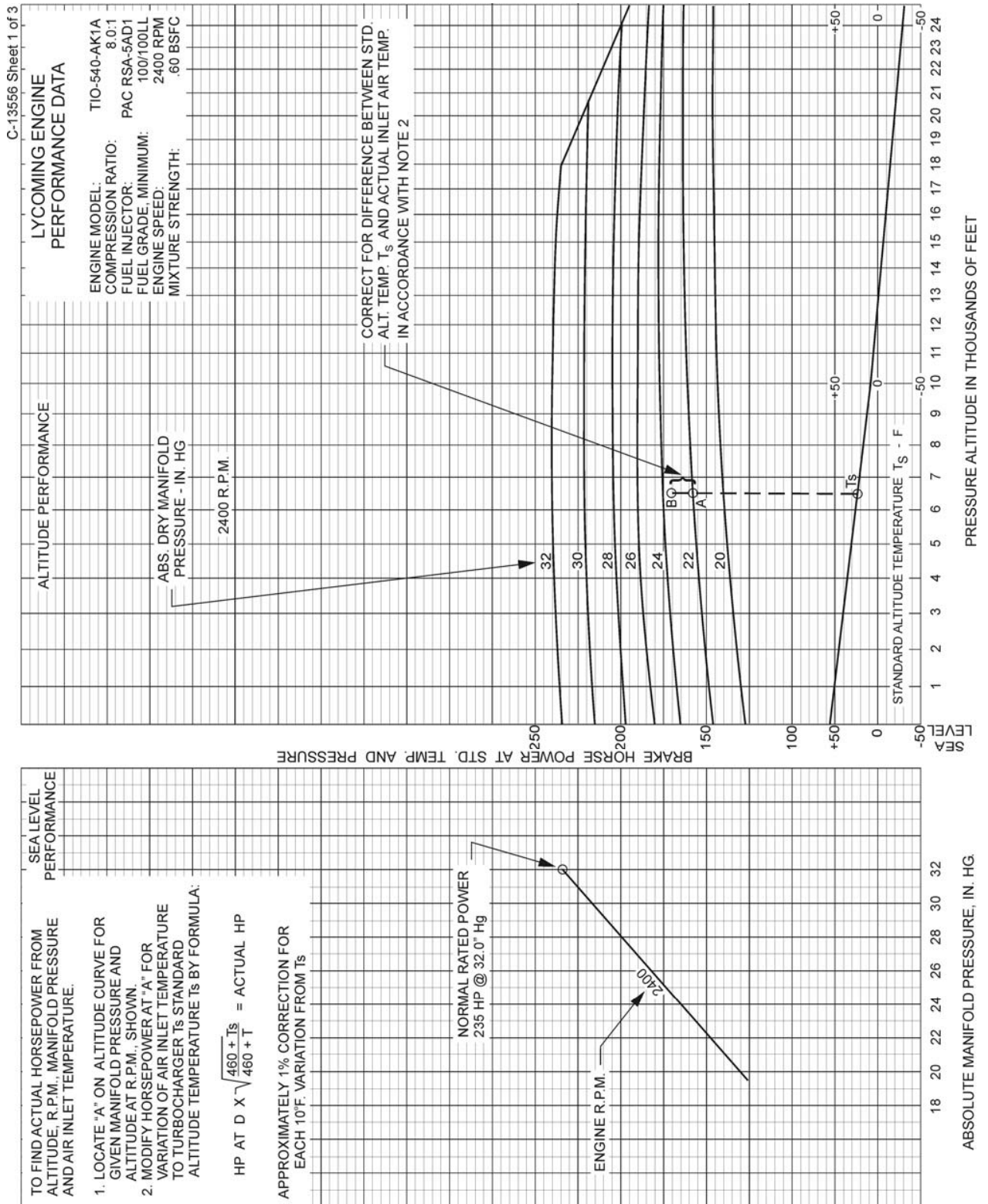

Figure 3-41. Sea Level/Altitude Performance Curve – TIO-540-AK1A (Sheet 1 of 3)

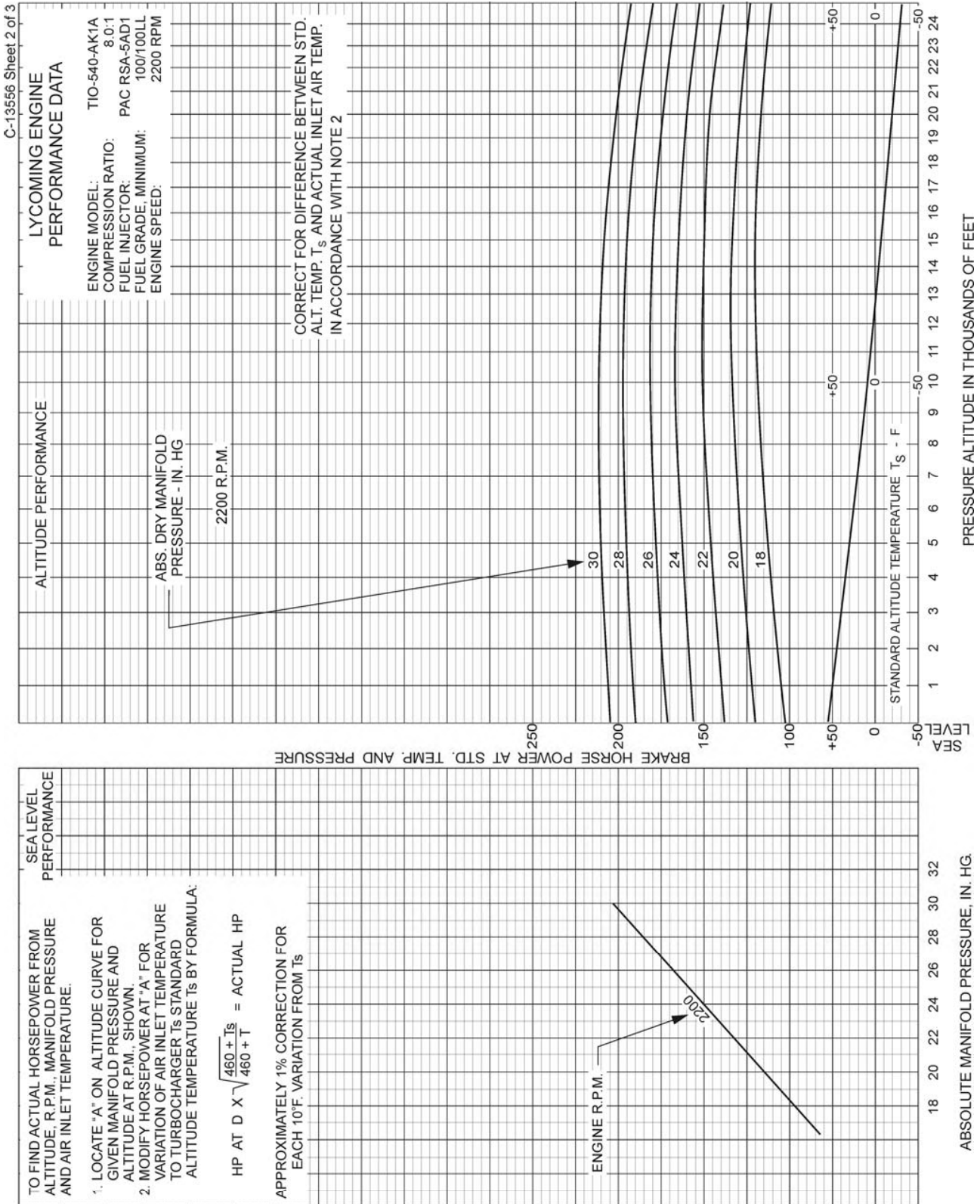

Figure 3-42. Sea Level/Altitude Performance Curve – TIO-540-AK1A (Sheet 2 of 3)

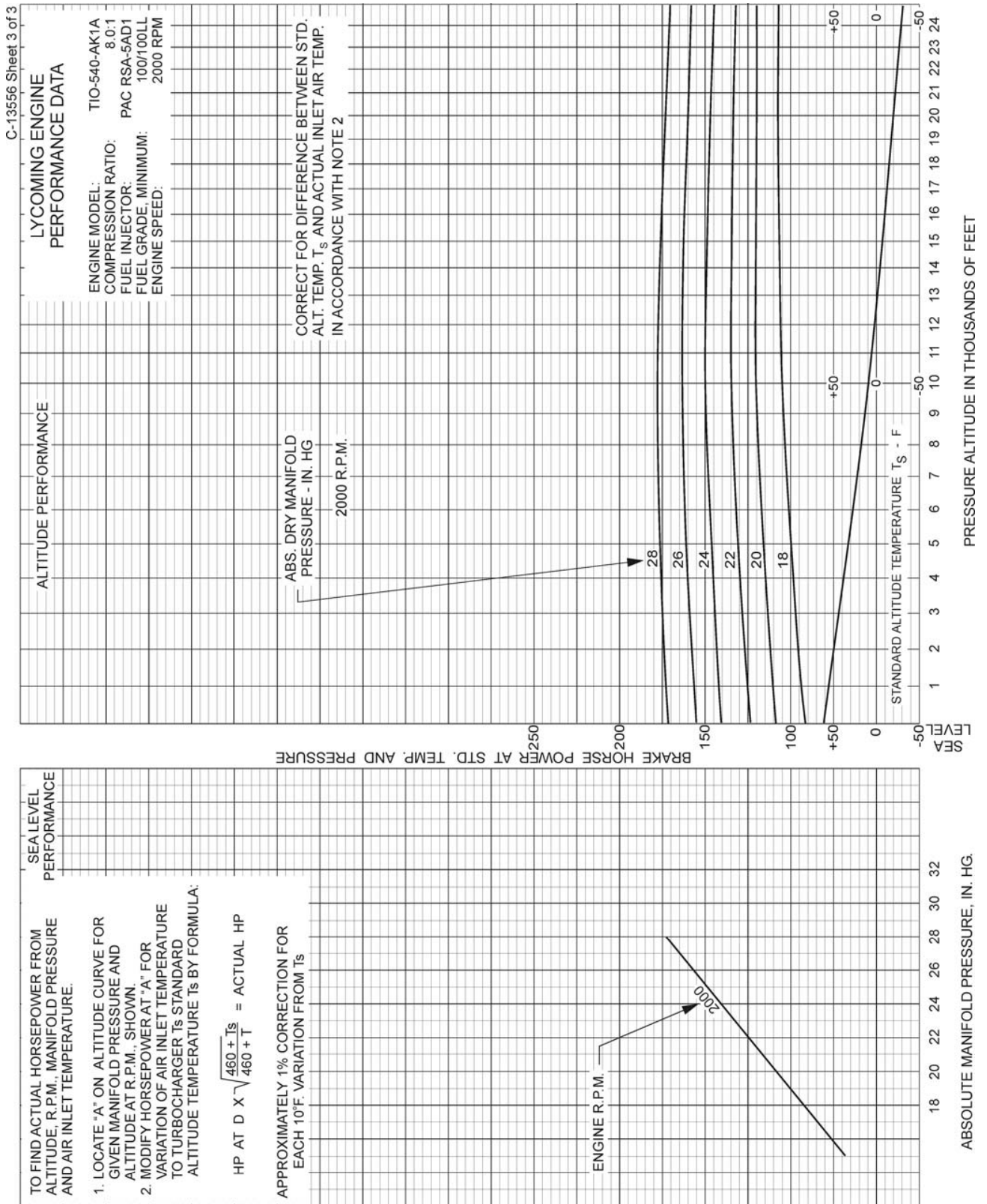

Figure 3-43. Sea Level/Altitude Performance Curve – TIO-540-AK1A (Sheet 3 of 3)

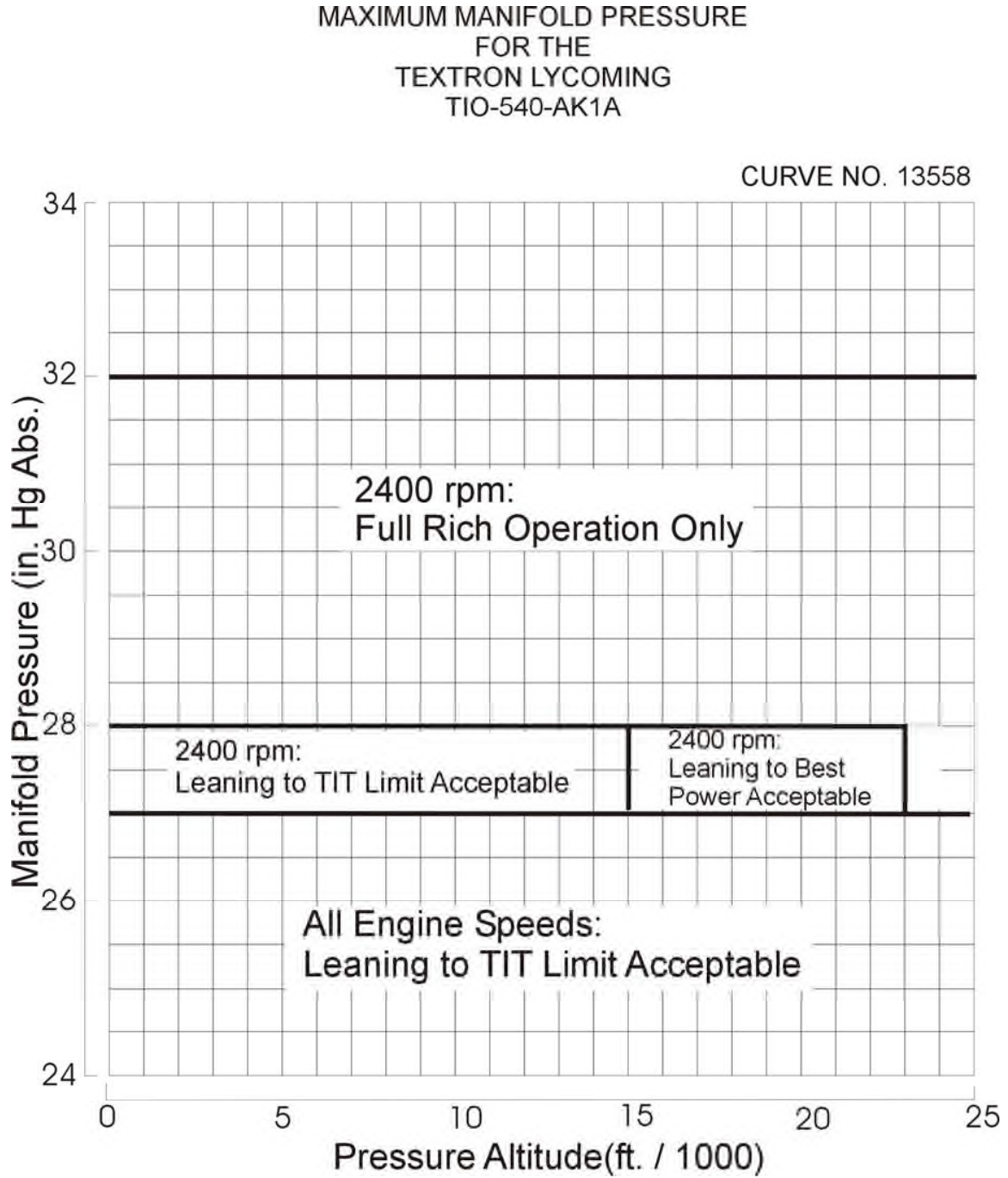

Figure 3-44. Maximum Manifold Pressure vs Altitude – TIO-540-AK1A



# LYCOMING OPERATOR'S MANUAL

## SECTION 4 PERIODIC INSPECTIONS

	Page
General.....	4-1
Pre-Starting Inspection .....	4-1
Daily Pre-Flight (Engine) .....	4-2
Daily Pre-Flight (Turbocharger) .....	4-2
10-Hour Inspection .....	4-2
25-Hour Inspection .....	4-2
50-Hour Inspection .....	4-2
100-Hour Inspection .....	4-4
400-Hour Inspection .....	4-5
Non-Scheduled Inspections .....	4-5

**This Page Intentionally Left Blank**

**SECTION 4  
PERIODIC INSPECTIONS**

*NOTE*

*Perhaps no other factor is quite so important to safety and durability of the aircraft and its components as faithful and diligent attention to regular checks for minor troubles and prompt repair when they are found.*

The operator should bear in mind that the items listed in the following pages do not constitute a complete aircraft inspection, but are meant for the engine only. Consult the airframe manufacturer's handbook for additional instructions.

*Pre-Starting Inspection* – The daily pre-flight inspection is a check of the aircraft prior to the first flight of the day. This inspection is to determine the general condition of the aircraft and engine.

The importance of proper pre-flight inspection cannot be over emphasized. Statistics prove several hundred accidents occur yearly directly responsible to poor pre-flight inspections.

Among the major causes of poor pre-flight inspection are lack of concentration, reluctance to acknowledge the need for a check list, carelessness bred by familiarity and haste.

*1. DAILY PRE-FLIGHT (ENGINE).*

- a. Be sure all switches are in the “Off” position.
- b. Be sure magneto ground wires are connected.
- c. Check oil level.
- d. See that fuel tanks are full.
- e. Check fuel and oil line connections, note minor indications for repair at 50-hour inspection. Repair any leaks before aircraft is flown.
- f. Open the fuel drain to remove any accumulation of water and sediment.
- g. Make sure all shields and cowling are in place and secure. If any are missing or damaged, repair, or replacement should be made before the aircraft is flown.
- h. Check controls for general condition, travel, and freedom of operation.
- i. Induction system air filter should be inspected and serviced in accordance with the airframe manufacturer's recommendations.

*2. DAILY PRE-FLIGHT (TURBOCHARGER).*

- a. Inspect mounting and connections of turbocharger for security, oil leakage, and air or exhaust gas leakage.
- b. Check engine crankcase breather for restrictions to breather.

*3. 10-HOUR INSPECTION (ENGINE).* Within ten (10) hours of operating time, for new, rebuilt, or newly overhauled engines, replace the oil filter, and conduct an inspection of the contents of the used oil filter for traces of metal particles.

*4. 25-HOUR INSPECTION (ENGINE).* After twenty-five (25) hours of operating time since the first inspection, new, rebuilt, or newly overhauled engines should undergo a 50-hour inspection including draining and renewing lubricating oil, replacing the oil filter, and inspecting the contents of the used oil filter.

**NOTE**

*All TIO-540-AF1A, -AF1B engines, or if an engine does not have a full-flow oil filter, change oil every 25 hours; also, inspect oil pressure and suction screens for metal contamination, and clean thoroughly before reinstallation.*

*5. 50-HOUR INSPECTION (ENGINE).* In addition to the items listed for daily pre-flight inspection, the following maintenance checks should be made after every 50 hours of operation.

*a. Ignition System –*

- (1) If fouling of spark plugs has been apparent, rotate bottom plugs to upper position.
- (2) Examine spark plug leads of cable and ceramics for corrosion and deposits. This condition is evidence of either leaking spark plugs, improper cleaning of spark plug walls or connector ends. Where this condition is found, clean the cable ends, spark plug walls and ceramics with a dry, clean cloth or a clean cloth moistened with methyl-ethyl ketone. All parts should be clean and dry before reassembly.
- (3) Check ignition harness for security of mounting clamps and be sure connections are tight at spark plug and magneto terminals.

*b. Fuel and Induction System –* Check the primer lines for leaks and security of the clamps. Remove and clean the fuel inlet strainers. Check the mixture control and throttle linkage for travel, freedom of movement, security of the clamps and lubricate if necessary. Check the air intake ducts for leaks, security, filter damage; evidence of dust or other solid material in the ducts is indicative of inadequate filter care or damaged filter. Check vent lines for evidence of fuel or oil seepage; if present, fuel pump may require replacement.

*c. Lubrication System –*

- (1) Check oil lines for leaks, particularly at connections; for security of anchorage and for wear due to rubbing or vibration, for dents and cracks.
- (2) Replace elements on external full flow oil filters. Before disposing of used element check interior fold for traces of metal particles that might be evidence of internal engine damage. Drain and renew lubricating oil on installations not employing replaceable full flow filters.

*d. Exhaust System –* Check attaching flanges at exhaust ports on cylinders for evidence of leakage. If they are loose, they must be removed and machined flat before they are reassembled and tightened. Examine exhaust manifolds for general condition.

*e. Cooling System –* Check cowling and baffles for damage and secure anchorage. Any damaged or missing part of the cooling system must be repaired or replaced before the aircraft resumes operation.

*f. Cylinders –* Check rocker box covers for evidence of oil leaks. If found, replace gasket and tighten screws to specified torque (50 in.-lbs.).

Check cylinders for evidence of excessive heat which is indicated by burned paint on the cylinder. This condition is indicative of internal damage to the cylinder and, if found, its cause must be determined and corrected before the aircraft resumes operation.

Heavy discoloration and appearance of seepage at cylinder head and barrel attachment area is usually due to emission of thread lubricant used during assembly of the barrel at the factory, or by slight gas leakage which stops after the cylinder has been in service for awhile. This condition is neither harmful nor detrimental to engine performance and operation. If it can be proven that leakage exceeds these conditions, the cylinder should be replaced.

- g. *Turbocharger* – All fluid power lines and mounting brackets incorporated in turbocharger system should be checked for leaks, tightness and any damage that may cause a restriction.

Check for accumulation of dirt or other interference with the linkage between the bypass valve and the actuator which may impair operation of turbocharger. Clean or correct cause for interference.

The vent line from the actuator should be checked for oil leakage. Any constant oil leakage is cause for replacement of piston seal.

Check alternate air valve to be sure it swings free and seals tightly.

6. *100-HOUR INSPECTION*. In addition to the items listed for daily pre-flight and 50-hour inspection, the following maintenance checks should be made after every one hundred hours of operation.

- a. *Electrical System* –

(1) Check all wiring connected to the engine or accessories. Any shielded cables that are damaged should be replaced. Replace clamps or loose wires and check terminals for security and cleanliness.

(2) Remove spark plugs; test, clean and regap. Replace if necessary.

- b. *Lubrication System* – Drain and renew lubricating oil.

- c. *Magnetos* – Check breaker points for pitting and minimum gap. Check for excessive oil in the breaker compartment; if found, wipe dry with a clean lintless cloth. The felt located at the breaker points should be lubricated in accordance with the magneto manufacturer's instructions. Check magneto to engine timing. Timing procedure is described in Section 5, 1, b of this manual.

*NOTE*

*Engines equipped with pressurized ignition system should be checked using the Bendix model 11-10090 airflow tester as described in the latest revision of Service Instruction No. 1308.*

- d. *Engine Accessories* – Engine mounted accessories such as pumps, temperature and pressure sensing units should be checked for secure mounting, tight connections.
- e. *Cylinders* – Check cylinders visually for cracked or broken fins.
- f. *Engine Mounts* – Check engine mounting bolts and bushings for security and excessive wear. Replace any bushings that are excessively worn.
- g. *Fuel Injector Nozzles and Lines* – Check fuel injector nozzles for looseness. Tighten to 60 in.-lbs. torque. Check fuel line for dye stains at connections (indicating leakage) and security of lines. Repair or replacement must be accomplished before aircraft resumes operation.
- h. *Turbocharger* – Inspect all air ducting and connections in turbocharger system for leaks. Make inspection both with engine shut down and with engine running. Check at manifold connections to turbine inlet and at engine exhaust manifold gasket, for possible air leakage.

*CAUTION*

*DO NOT OPERATE THE TURBOCHARGER IF LEAKS EXIST IN THE DUCTING, OR IF AIR CLEANER IS NOT FILTERING EFFICIENTLY. DUST LEAKING INTO AIR DUCTING CAN DAMAGE TURBOCHARGER AND ENGINE.*

Check for dirt or dust build-up within the turbocharger. Check for uneven deposits on the impeller. Consult AiResearch Industrial Div. Manual TP-21 for method to remove all such foreign matter.

Check the condition of the flexible hoses in the turbocharger system. Stiffness of the hose is indicative of deterioration and if this condition is noted the hose should be replaced before further flight.

**7. 400-HOUR INSPECTION.** In addition to the items listed for daily pre-flight, 50-hour and 100-hour inspections, the following maintenance check should be made after every 400 hours of operation.

*Valve Inspection* – Remove rocker box covers and check for freedom of valve rockers when valves are closed. Look for evidence of abnormal wear or broken parts in the area of the valve tips, valve keeper, springs and spring seats. If any indications are found, the cylinder and all of its components should be removed (including the piston and connecting rod assembly) and inspected for further damage. Replace any parts that do not conform to the limits shown in the latest revision of Special Service Publication No. SSP-1776.

**8. NON-SCHEDULED INSPECTIONS.** Occasionally, service bulletins, or service instructions are issued by Lycoming that require inspection procedures that are not listed in this manual. Such publications, usually are limited to specified engine models and become obsolete after corrective modification has been accomplished. All such publications are available from Lycoming distributors, or from the factory by subscription. Consult the latest revision of Service Letter No. L114 for subscription information. Maintenance facilities should have an up-to-date file of these publications available at all times.

**This Page Intentionally Left Blank**



# LYCOMING OPERATOR'S MANUAL

## SECTION 5 MAINTENANCE PROCEDURES

	Page
General.....	5-1
<b>Ignition and Electrical System</b>	
Ignition Harness and Wire Replacement.....	5-1
<b>Timing Magnetos to Engine</b>	
Single Magneto .....	5-1
Dual Magnetos.....	5-1
Generator or Alternator Output .....	5-6
<b>Fuel System</b>	
Repair of Fuel Leaks.....	5-6
Fuel Injector Inlet Screen Assembly .....	5-6
Air Intake Ducts and Filter .....	5-6
Idle Speed and Mixture Adjustment.....	5-6
<b>Lubrication System</b>	
Oil Grades and Limitations.....	5-7
Oil Suction and Oil Pressure Screens .....	5-7
Oil Relief Valve .....	5-7
Cylinders.....	5-8
<b>Turbocharger</b>	
Density Controller.....	5-11
Generator or Alternator Drive Belt Tension.....	5-12

**This Page Intentionally Left Blank**

## SECTION 5

### MAINTENANCE PROCEDURES

The procedures described in this section are provided to guide and instruct personnel in performing such maintenance operations that may be required in conjunction with the periodic inspections listed in the preceding section. No attempt is made to include repair and replacement operations that will be found in the applicable Lycoming Overhaul Manual.

#### 1. IGNITION AND ELECTRICAL SYSTEM.

- a. *Ignition Harness and Wire Replacement* – In the event that an ignition harness or an individual lead is to be replaced, consult the wiring diagram to be sure harness is correctly installed. Mark location of clamps and clips to be certain the replacement is clamped at correct locations.
- b. *Timing Magneto to Engine* –
  - (1) Remove spark plug from No. 1 cylinder and place a thumb over the spark plug hole. Rotate the crankshaft in direction of normal rotation until the compression stroke is reached, this is indicated by a positive pressure inside the cylinder tending to push the thumb off the spark plug hole. Continue rotating the crankshaft until the advance timing mark on the front face of the starter ring gear is in alignment with the small hole located at the two o'clock position on the front face of the starter housing. (Ring gear may be marked at 20°, 23°, and 25°. Consult specifications for correct timing mark for your installation.) At this point, the engine is ready for assembly of the magnetos.
  - (2) *Single Magneto* – Remove the inspection plugs from both magnetos and turn the drive shaft in direction of normal rotation until (-1200 series) the application timing mark on the distributor gear is approximately aligned with the mark on the distributor block. See Figure 5-2. Being sure the gear does not move from this position, install gaskets and magnetos on the engine. Note that an adapter is used with all magnetos. Secure with (clamps on -1200 series) washers and nuts; tighten only finger tight.
  - (3) Using a battery powered timing light, attach the positive lead to a suitable terminal connected to the switch terminal of the magneto and the negative lead to any unpainted portion of the engine. Rotate the magneto in its mounting flange to a point where the light comes on, then slowly turn it in the opposite direction until the light goes out. Bring the magneto back slowly until the light just comes on. Repeat this with the second magneto.
  - (4) Back off the crankshaft a few degrees, the timing light should go out. Bring the crankshaft slowly back in direction of normal rotation until the timing mark and the hole in the starter housings are in alignment. At this point, both lights should go on simultaneously. Tighten nuts to specified torque.
  - (5) *Dual Magnetos* – Place the engine in the No. 1 advance firing position as directed in paragraph 1b(1).
  - (6) Install the magneto-to-engine gasket on the magneto flange.

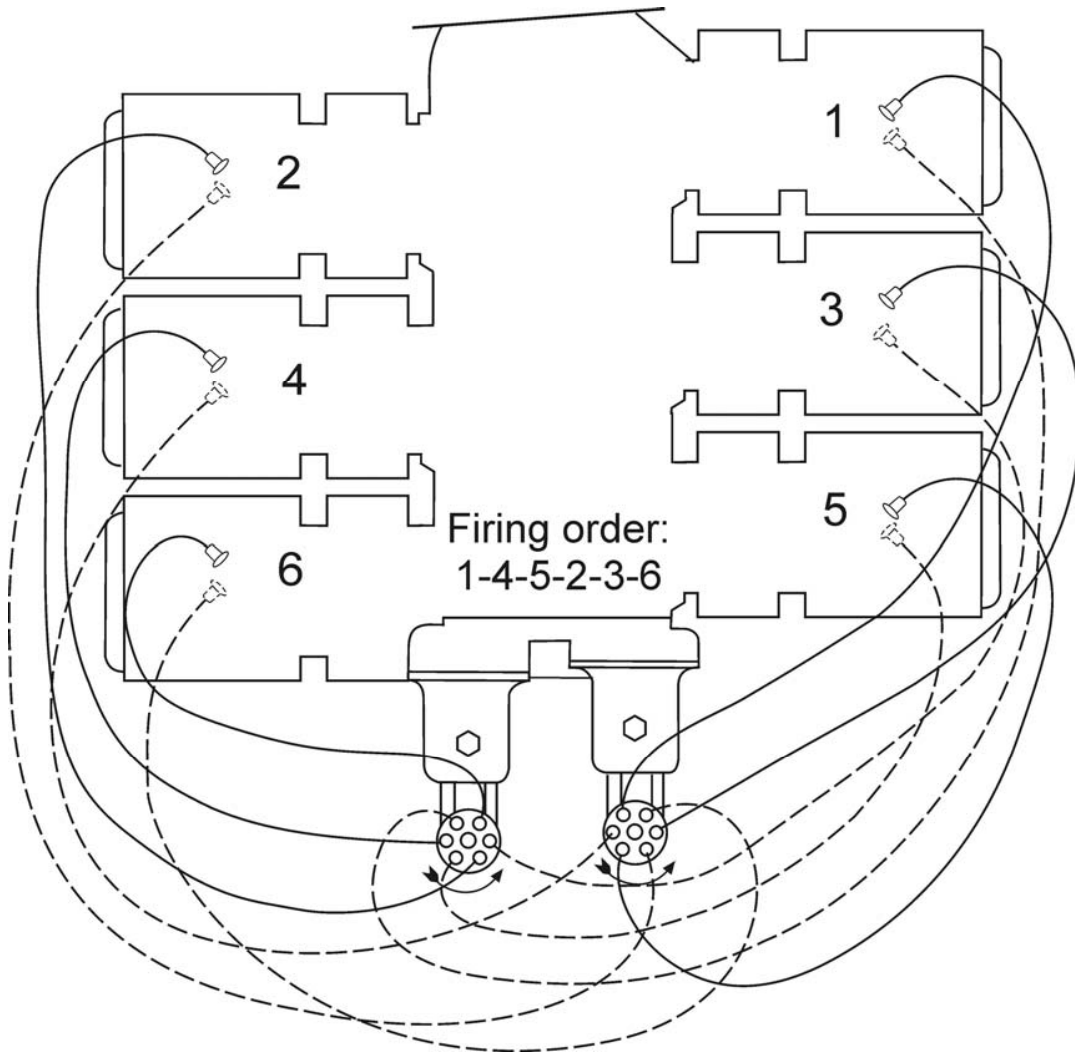

Figure 5-1. Ignition Wiring Diagram

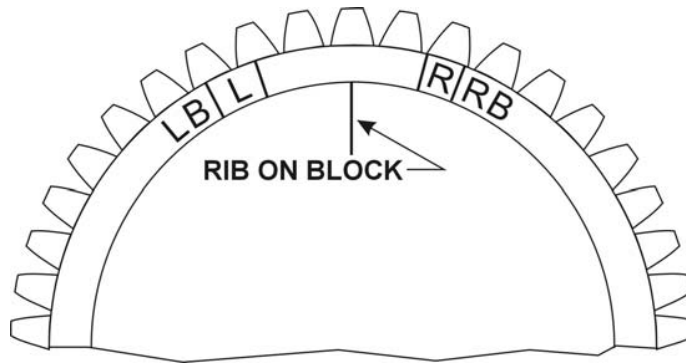

Figure 5-2. Timing Marks - 6 Cyl. -1200 Series

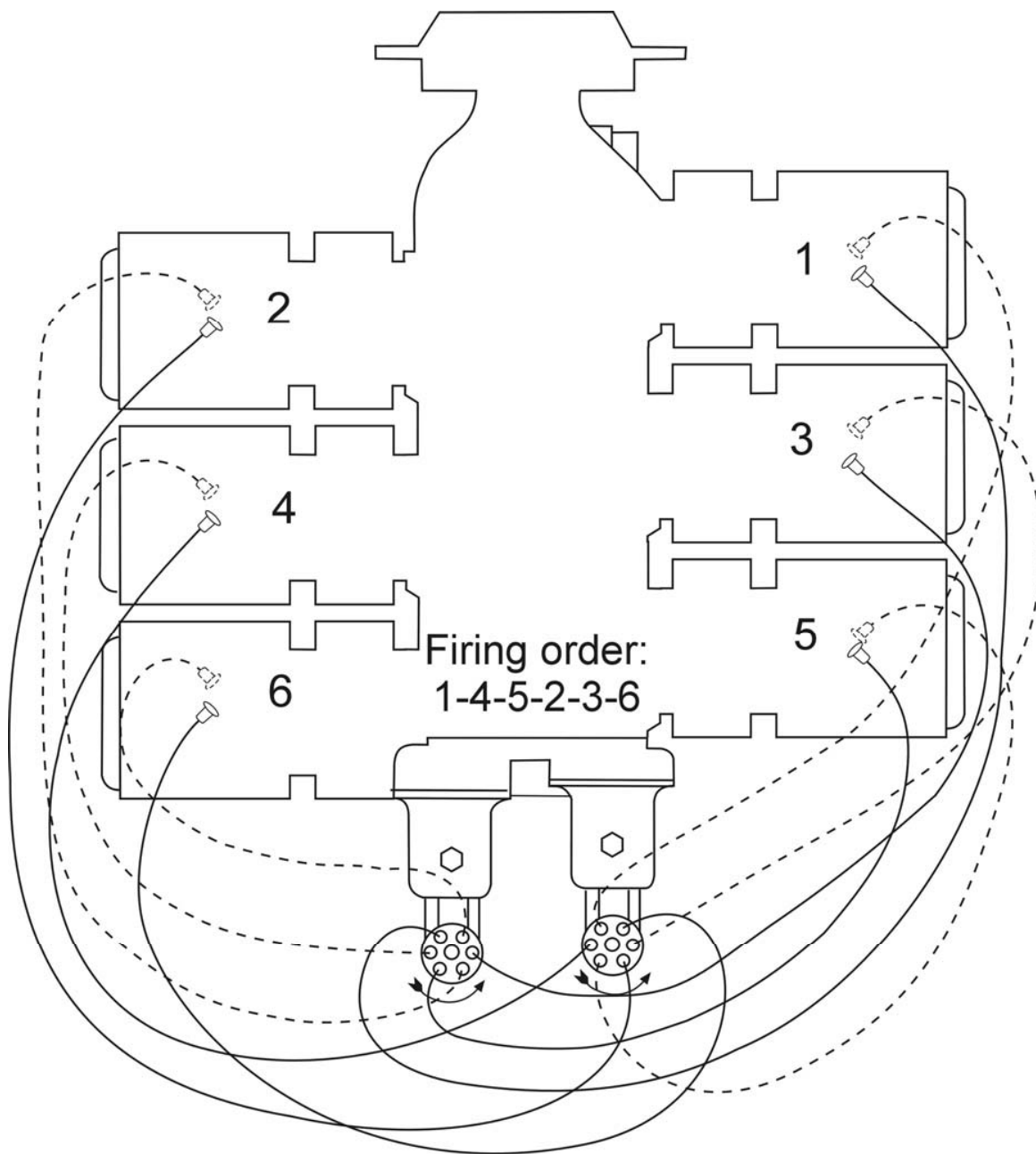

Figure 5-3. Ignition Wiring – Dual Magneto

*WARNING*

*DO NOT ATTACH HARNESS SPARK PLUG ENDS TO THE SPARK PLUGS UNTIL ALL MAGNETO-TO-ENGINE TIMING PROCEDURES AND MAGNETO-TO-SWITCH CONNECTIONS ARE ENTIRELY COMPLETED.*

- (7) To remove engine-to-magneto drive gear train backlash by turning engine magneto drive as far as possible in direction opposite to normal rotation and then return in the direction of normal rotation to timing mark on starter support.
- (8) Remove the timing window plug from the most convenient side of the magneto housing and the plug from the rotor viewing location in the center of the housing.
- (9) Turn the rotating magnet drive shaft in the normal direction of magneto rotation until the painted tooth of the large distributor gear is centered in the timing hole.
- (10) Observe that at this time the built in pointer just ahead of the rotor viewing window aligns with the R or L mark on the rotor depending on whether the magneto is of right or left hand rotation as specified on the magneto nameplate.
- (11) Hold the magneto in its No. 1 firing position (tooth in window center and pointer over R or L mark on rotor) and install magneto to the engine and loosely clamp in position.
- (12) Attach red lead from the timing light to left switch adapter lead, green lead of timing light to right switch adapter lead and the black lead of the light to magneto housing.
- (13) Turn the entire magneto in direction of rotor rotation until the red timing light comes on.
- (14) Rotate the magneto in the opposite direction until the red light just goes off indicating left main breaker has opened. Then evenly tighten the magneto mounting clamps.
- (15) Back the engine up approximately 10° and then carefully “bump” the engine forward at the same time observing the timing lights.
- (16) At the No.1 firing position of the engine, the red light should go off indicating left main breaker opening. The right main breaker, monitored by the green light, must open within ± 2 engine degrees of the No. 1 firing position.
- (17) Repeat steps (13) thru (15) until the condition described in paragraph (16) is obtained.
- (18) Complete tightening of the magneto securing clamps by torquing to 150 in.-lbs.
- (19) Recheck timing once more and if satisfactory disconnect timing light. Remove adapter leads.
- (20) Reinstall plugs in timing inspection holes and torque to 12-15 in.-lbs.

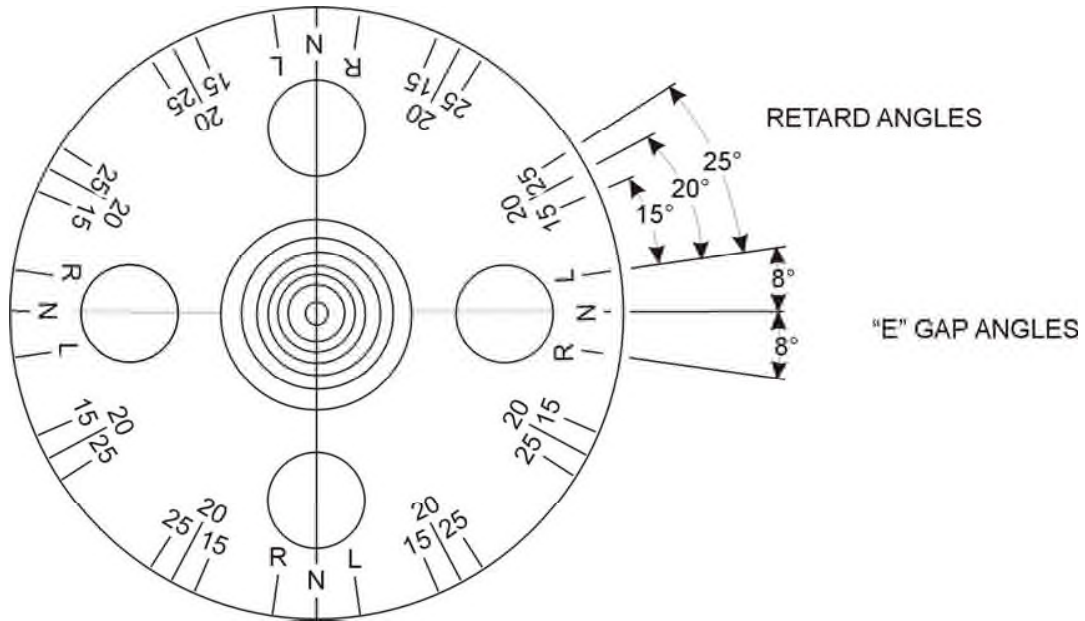

Figure 5-4. Timing Marks on Rotating Magnet

**NOTE**

*Some timing lights operate in the reverse manner as described. The light comes on when the breaker points open. Check your timing light instructions.*

- c. *Internal Timing – Dual Magneto* – Check the magneto internal timing and breaker synchronization in the following manner.
- (1) *Main Breakers* – Connect the timing light negative lead to any unpainted surface of the magneto. Connect one positive lead to the left main breaker terminal and the second positive lead to the right main breaker terminal.
  - (2) Back the engine up a few degrees and again bump forward toward number one cylinder firing position while observing timing lights. Both lights should go out to indicate opening of the main breakers when the timing pointer is indicating within the width of the “L” or “R” mark. If breaker timing is incorrect, loosen breaker screws and correct. Retorque breaker screws to 20 to 25 in.-lbs.
  - (3) *Retard Breaker* – Remove timing light leads from the main breaker terminals. Attach one positive lead to retard breaker terminal, and second positive lead to the tachometer breaker terminal, if used.
  - (4) Back the engine up a few degrees and again bump forward toward number one cylinder firing position until pointer is aligned with 15° retard timing mark. See Figure 5-4. Retard breaker should just open at this position.
  - (5) If retard timing is not correct, loosen cam securing screw and turn the retard breaker cam as required to mark retard breaker open per paragraph c(4). Retorque cam screw to 16 to 20 in.-lbs.

- (6) Observe that tachometer breaker is opened by the cam lobe. No synchronization of this breaker is required.
  - (7) Check action of impulse coupling (D-2000 series only). With the ignition switch off observe breaker cam end of rotor while manually cranking engine through a firing sequence. Rotor should alternately stop and then (with an audible snap) be rotated rapidly through a retard firing position.
- d. *Generator or Alternator Output* – The generator or alternator (whichever is applicable) should be checked to determine that the specified voltage and current are being obtained.

**2. FUEL SYSTEM.**

- a. *Repair of Fuel Leaks* – In the event a line or fitting in the fuel system is replaced, use only a fuel soluble lubricant, such as Loctite Hydraulic Sealant. Do not use Teflon tape or any other form of thread compound. Do not apply sealant to the first two threads.
- b. *Fuel Injector Inlet Screen Assembly* – Remove the assembly and check the screen for distortion or openings in the strainer. Replace for either of these conditions. Clean screen assembly in solvent and dry with compressed air. To install the screen assembly, place the gasket on the screen assembly and install the assembly in the throttle body and tighten to 60 to 70 in.-lbs. torque.
- c. *Fuel Grades and Limitations* – See recommended fuel grades in Section 3.

In the event that the specified fuel is not available at some locations, it is permissible to use higher octane fuel. Fuel of a lower octane than specified is not to be used. Under no circumstances should automotive fuel be used (regardless of octane rating).

**NOTE**

*It is recommended that personnel be familiar with the latest revision of Service Instruction No. 1070 regarding specified fuel for Lycoming engines.*

- d. *Air Intake Ducts and Filter* – Check all air intake ducts for dirt or restrictions. Inspect and service oil filters as instructed in the airframe manufacturer's handbook.
- e. *Idle Speed and Mixture Adjustment* –
  - (1) Start the engine and warm-up in the usual manner until oil and cylinder head temperatures are normal.
  - (2) Check magnetos. If the "mag-drop" is normal, proceed with idle adjustment.
  - (3) Set throttle stop screw so that the engine idles at the airframe manufacturer's recommended idling RPM. If the RPM changes appreciably after making idle mixture adjustment during the succeeding steps, readjust the idle speed to the desired RPM.



- (4) When the idling speed has been stabilized, move the cockpit mixture control lever with a very slow, steady pull toward the "Idle Cut-Off" position and observe the tachometer for any change during the leaning process. Caution must be exercised to return the mixture control to the "Full Rich" position before the RPM can drop to a point where the engine cuts out. An increase of more than 35 RPM while "leaning out" indicates an excessively rich idle mixture. An immediate decrease in RPM (if not preceded by momentary increase) indicates the idle mixture is too lean.

If the above indicates that the idle adjustment is too rich or too lean, turn the idle mixture adjustment in the direction required for correction, and check this new position by repeating the above procedure. Make additional adjustments as necessary until a check results in a momentary pick-up of approximately 10 to 25 RPM. Each time the adjustment is changed, the engine should be run up to 2000 RPM to clear the engine before proceeding with the RPM check. Make final adjustment of the idle speed adjustment to obtain the desired idling RPM with closed throttle. The above method aims at a setting that will obtain maximum RPM with minimum manifold pressure. In case the setting does not remain stable, check the idle linkage; any looseness in this linkage would cause erratic idling. In all cases, allowance should be made for the effect of weather conditions and field altitude upon idling adjustment.

### 3. LUBRICATION SYSTEM.

- a. *Oil Grades and Limitation* – Service the engine in accordance with the recommendations shown in Section 3.
- b. *Oil Suction and Oil Pressure Screens* – At each fifty hours inspection remove, inspect for metal particles, clean and reinstall.

#### NOTE

*On installations employing external oil filters, step 3, b is not practical at this time. But should be observed at the 100-hour inspection.*

- c. *Oil Relief Valve (Non-Adjustable)* – The function of the oil pressure relief valve is to maintain engine oil pressure within specified limits. The valve, although not adjustable, may be controlled by the addition of a maximum of nine STD-425 washers under the cap to increase pressure or the use of a spacer (Lycoming P/N 73629 or 73630) to decrease pressure. A modification on later models has eliminated the need for the spacers. Particles of metal or other foreign matter lodged between the ball and seat will result in faulty readings. It is advisable, therefore, to disassemble, inspect and clean the valve if excessive pressure fluctuations are noted.
- d. *Oil Relief Valve (Adjustable)* – The adjustable oil relief valve enables the operator to maintain engine oil pressure within the specified limits. If the pressure under normal operating conditions should consistently exceed the maximum or minimum specified limits, adjust the valve as follows:

With the engine warmed up and running at approximately 2000 RPM, observe the reading on the oil pressure gage. If the pressure is above maximum or below minimum specified limits, stop engine and screw the adjusting screw out to decrease pressure and in to increase pressure. Depending on installation, the adjusting screw may have only a screw driver slot and is turned with a screw driver; or may have the screw driver slot plus a pinned .375-24 castellated nut and may be turned with either a screw driver or a box wrench.

4. *CYLINDERS*. It is recommended that as a field operation, cylinder maintenance be confined to replacement of the entire assembly. For valve replacement, consult the proper overhaul manual. This should be undertaken only as an emergency measure.

*a. Removal of Cylinder Assembly –*

- (1) Remove exhaust manifold.
- (2) Remove rocker box drain tube, intake pipe, baffle and any clips that might interfere with the removal of the cylinder.
- (3) Disconnect ignition cables and remove the bottom spark plug.
- (4) Remove rocker box cover and rotate crankshaft until piston is approximately at top center of the compression stroke. This is indicated by a positive pressure inside of cylinder tending to push thumb off of bottom spark plug hole.
- (5) Slide valve rocker shafts from cylinder head and remove the valve rockers. Valve rocker shafts can be removed when the cylinder is removed from the engine. Remove rotator cap from exhaust valve stem.
- (6) Remove push rod by grasping ball end and pulling rod out of shroud tube. Detach shroud tube spring and lock plate and remove shroud tubes from cylinder head.

*NOTE*

*The hydraulic tappets, push rods, rocker arms and valves must be assembled in the same location from which they were removed.*

- (7) Remove cylinder base nuts and hold down plates (where employed) then remove cylinder by pulling directly away from crankcase. Be careful not to allow the piston to drop against the crankcase, as the piston leaves the cylinder.
- b. Removal of Piston from Connecting Rod –* Remove the piston pin plugs. Insert piston pin puller through piston pin, assemble puller nut; then proceed to remove piston pin. Do not allow connecting rod to rest on the cylinder bore of the crankcase. Support the connecting rod with heavy rubber band, discarded cylinder base oil ring seal, or any other non-marring method.
- c. Removal of Hydraulic Tappet Sockets and Plunger Assemblies –* It will be necessary to remove and bleed the hydraulic tappet plunger assembly so that dry tappet clearance can be checked when the cylinder assembly is reinstalled. This is accomplished in the following manner:
- (1) Remove the hydraulic tappet push rod socket by inserting the forefinger into the concave end of the socket and withdrawing. If the socket cannot be removed in this manner, it may be removed by grasping the edge of the socket with a pair of needle nose pliers. However, care must be exercised to avoid scratching the socket.

- (2) To remove the hydraulic tappet plunger assembly, use the special Lycoming service tool. In the event that the tool is not available, the hydraulic tappet plunger assembly may be removed by a hook in the end of a short piece of lockwire, inserting the wire so that the hook engages the spring of the plunger assembly. Draw the plunger assembly out of the tappet body by gently pulling the wire.

*CAUTION*

*NEVER USE A MAGNET TO REMOVE HYDRAULIC PLUNGER ASSEMBLIES FROM THE CRANKCASE. THIS CAN CAUSE THE CHECK BALL TO REMAIN OFF ITS SEAT, RENDERING THE UNIT INOPERATIVE.*

- d. *Assembly of Hydraulic Tappet Plunger Assemblies* – To assemble the unit, unseat the ball by inserting a thin clean wire through the oil inlet hole. With the ball off its seat, insert the plunger and twist clockwise so that the spring catches. All oil must be removed before the plunger is removed.
- e. *Assembly of Cylinder and Related Parts* – Rotate the crankshaft so that the connecting rod of the cylinder being assembled is at the top center of compression stroke. This can be checked by placing two fingers on the intake and exhaust tappet bodies. Rock crankshaft back and forth over top center. If the tappet bodies do not move the crankshaft is on the compression stroke.
  - (1) Place each plunger assembly in its respective tappet body and assemble the socket on top of plunger assembly.
  - (2) Assemble piston with rings so that the number stamped on the piston pin boss is toward the front of the engine. The piston pin should be of a hand push fit. If difficulty is experienced in inserting the piston pin, it is probably caused by carbon or burrs in the piston pin hole. During assembly, always use a generous quantity of oil, both in the piston pin hole and on the piston pin.
  - (3) Assemble one piston pin plug at each end of the piston pin and place a new rubber oil seal ring around the cylinder skirt. Coat piston and rings and inside of the cylinder generously with oil.
  - (4) Using a piston ring compressor, assemble the cylinder over the piston so that the intake port is at the bottom of the engine. Push the cylinder all of the way on, catching the ring compressor as it is pushed off.

*NOTE*

*Before installing cylinder hold-down nuts, lubricate crankcase thru-stud threads with any one of the following lubricants, or combination of lubricants.*

1. 90% SAE 50W engine oil and 10% STP.
  2. Parker Thread Lube.
  3. 60% SAE 30 engine oil and 40% Parker Thread Lube.
- (5) Assemble hold-down plates (where applicable) and cylinder base hold-down nuts and tighten as directed in the following steps

NOTE

*At any time a cylinder is replaced, it is necessary to retorque the thru-studs on the cylinder on the opposite side of the engine.*

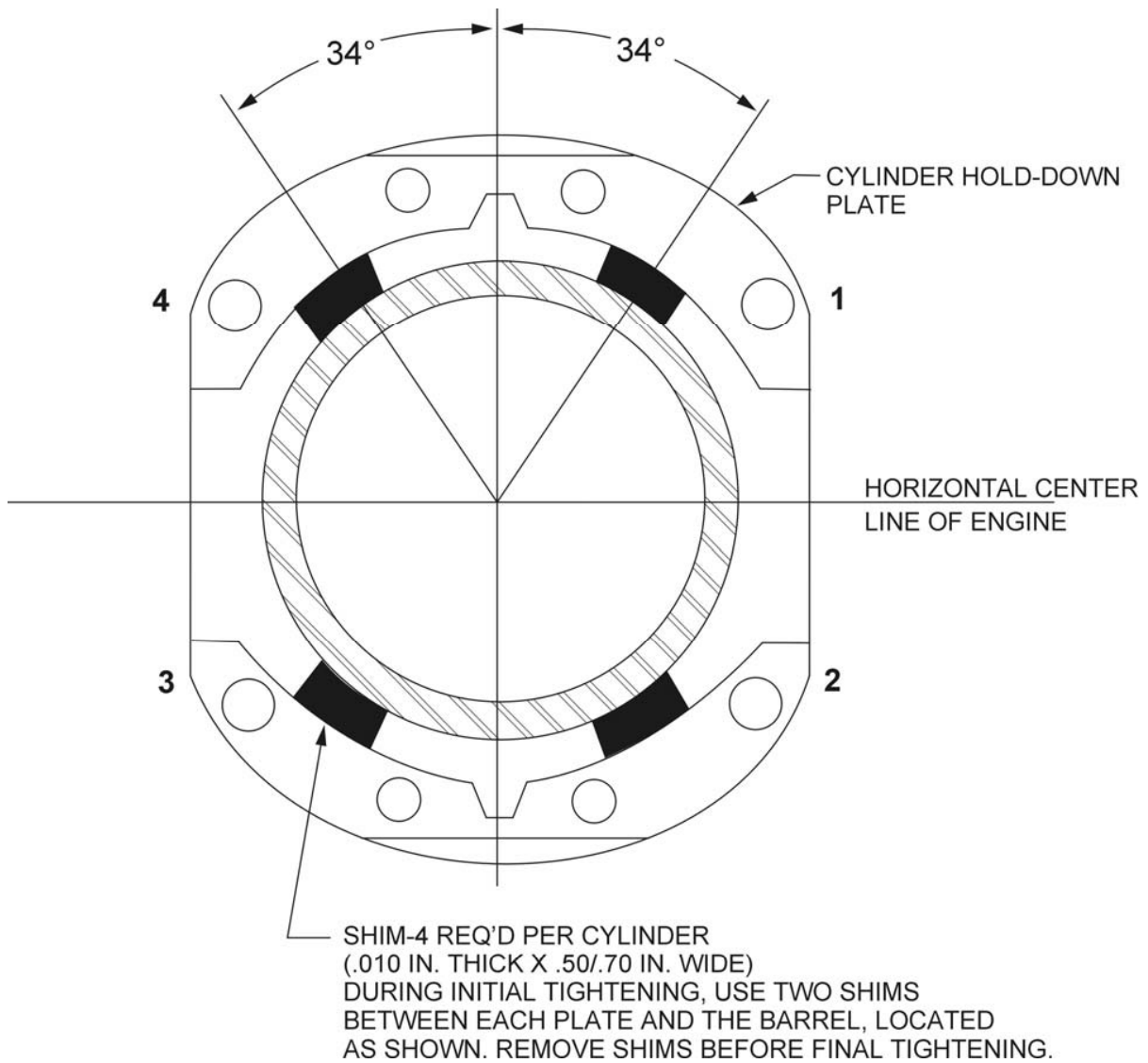

Figure 5-5. Location of Shims Between Cylinder Barrel and Hold-Down Plates (where applicable) and Sequence of Tightening Cylinder Base Hold-Down Nuts

- (a) (*Engines using hold-down plates*) – Install shims between cylinder base hold-down plates and cylinder barrel, as directed in Figure 5-5, and tighten ½ inch hold-down nuts to 300 in.-lbs. (25 ft.-lbs.) torque, using the sequence shown in Figure 5-5.
- (b) Remove shims and using the same sequence, tighten the ½ inch cylinder base nuts, to 600 in.-lbs. (50 ft.-lbs.) torque.

*NOTE*

*Cylinder assemblies not using hold-down plate are tightened in the same manner as above omitting the shims.*

- (c) Tighten the ⅜ inch hold-down nuts to 300 in.-lbs. (25 ft.-lbs.) torque. Sequence of tightening is optional.
- (d) As a final check, hold the torque wrench on each nut for about five seconds. If the nut does not turn, it may be presumed to be tightened to correct torque.

*CAUTION*

*AFTER ALL CYLINDER BASE NUTS HAVE BEEN TIGHTENED, REMOVE ANY NICKS IN THE CYLINDER FINS BY FILING OR BURRING.*

- (6) Install new shroud tube oil seals on both ends of shroud tube. Install shroud tube and lock in place as required for type of cylinder.
- (7) Assemble each push rod in its respective shroud tube, and assemble each rocker in its respective position by placing rocker between bosses and sliding valve rocker shaft in place to retain rocker. Before installing exhaust valve rocker, place rotator cap over end of exhaust valve stem.
- (8) Be sure that the piston is at top center of compression stroke and that both valves are closed. Check clearance between the valve stem tip and the valve rocker. In order to check this clearance, place the thumb of one hand on the valve rocker directly over the end of the push rod and push down so as to compress the hydraulic tappet spring. While holding the spring compressed, the valve clearance should be between .028 and .080 inch. If clearance does not come within these limits, remove the push rod and insert a longer or shorter push rod, as required to correct clearance.

*NOTE*

*Inserting a longer push rod will decrease the valve clearance.*

- (9) Install intercylinder baffles, rocker box covers, intake pipes, rocker box drain tubes and exhaust manifold.

**5. TURBOCHARGER.**

- a. *Density Controller* – The density controller is adjusted at the factory to maintain a predetermined constant for desired horsepower.

The density controller is set to a curve, see Figures 5-7 through 5-14 under the following conditions: Engines at operating temperature, full throttle with oil pressure at 80 psi  $\pm$  5 psi.

If it is suspected that either the manifold pressure or compressor discharge pressure is not within limits, it may be checked to the curve. See AiResearch Industrial Division Manual TP-21 for detailed information for setting.

*EXAMPLE*

*Operating at the stated conditions with a compressor discharge temperature of 120°F, the manifold pressure and compressor discharge pressure should be 38.6 in. Hg.  $\pm$  .3 in. Hg.*

If the manifold pressure is found to be out of limits, the cause might be found either in the density controller, the differential pressure controller or the waste gate. It is recommended that an authorized overhaul facility check these controls.

**6. GENERATOR OR ALTERNATOR DRIVE BELT TENSION.**

Check the tension of a new belt 25 hours after installation. Refer to the latest revision of Service Instruction No. 1129 for methods of checking generator or alternator drive belt tensions.

POWER CONTROL CHART 250 HP - 2575 RPM  
 DENSITY CONTROL FULL THROTTLE SETTING LIMITS

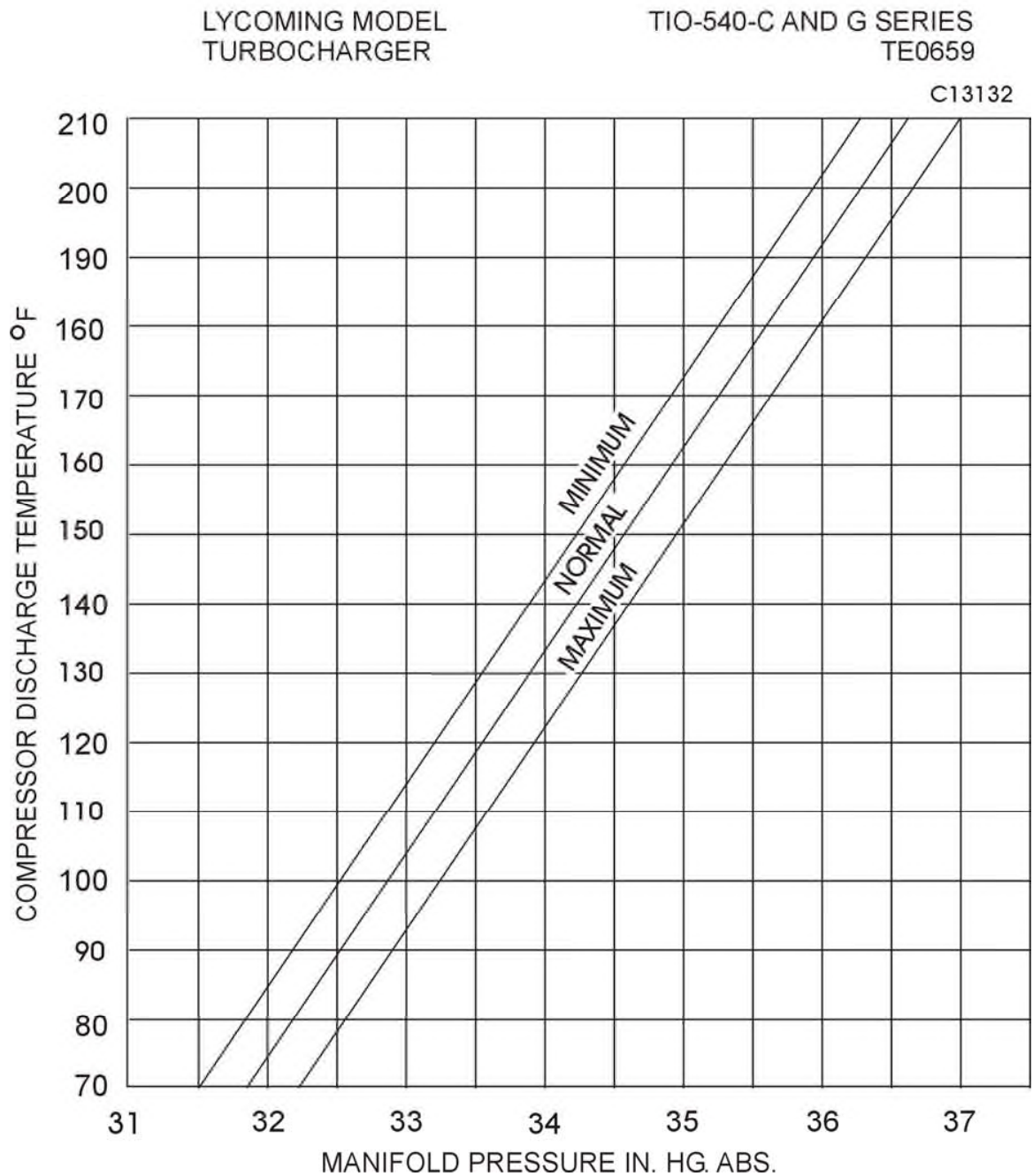

Figure 5-6. Density Control Full Throttle Setting Limits –  
 TIO-540-C1A, -G1A

POWER CONTROL CHART 260 HP - 2575 RPM  
DENSITY CONTROL FULL THROTTLE SETTING LIMITS

LYCOMING MODEL  
TURBOCHARGER

TIO-540-E1A  
TE0659

REF. LYCOMING CURVE NO. 3005-23

C13191

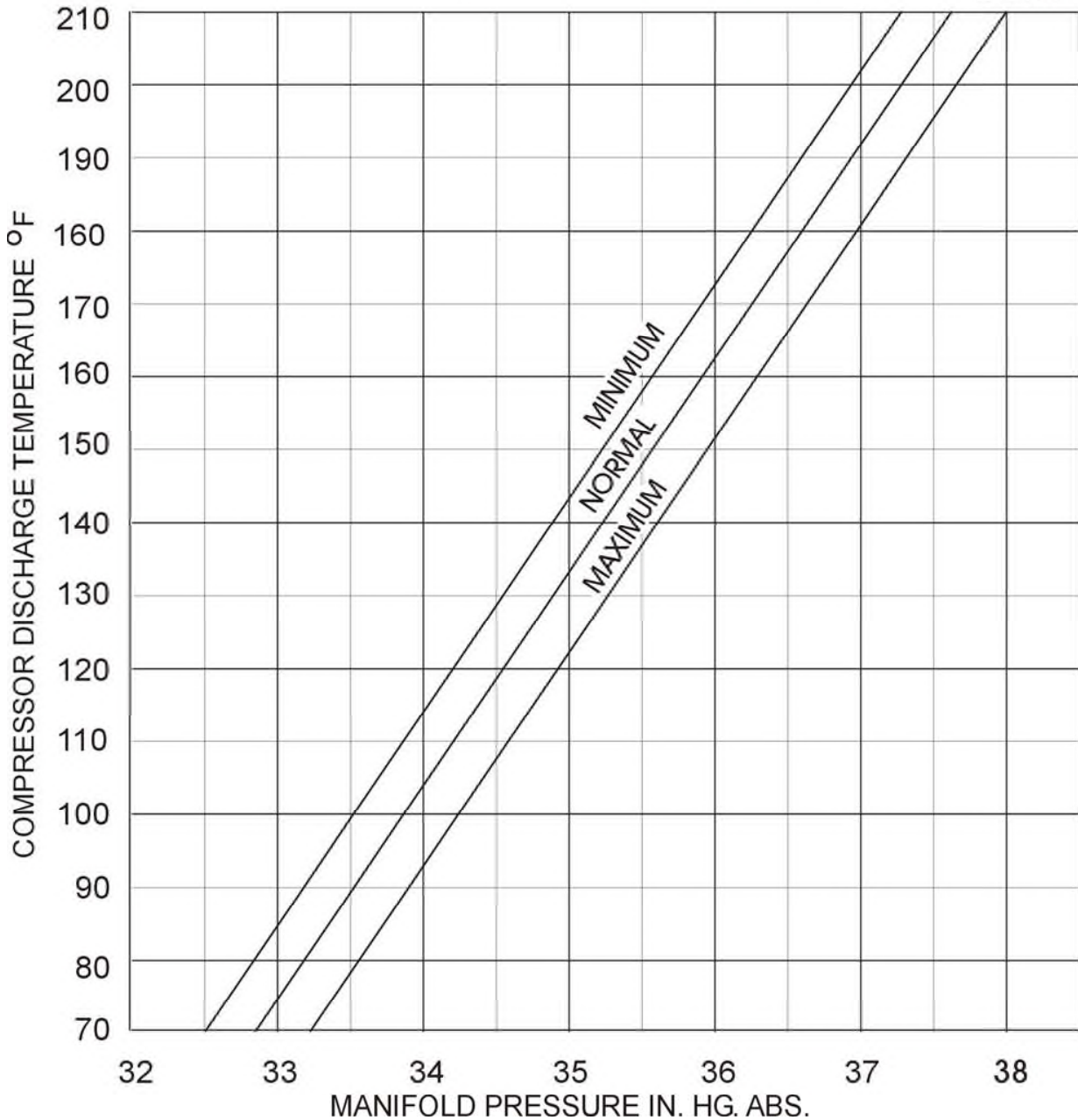

Figure 5-7. Density Control Full Throttle Setting Limits –  
TIO-540-E1A



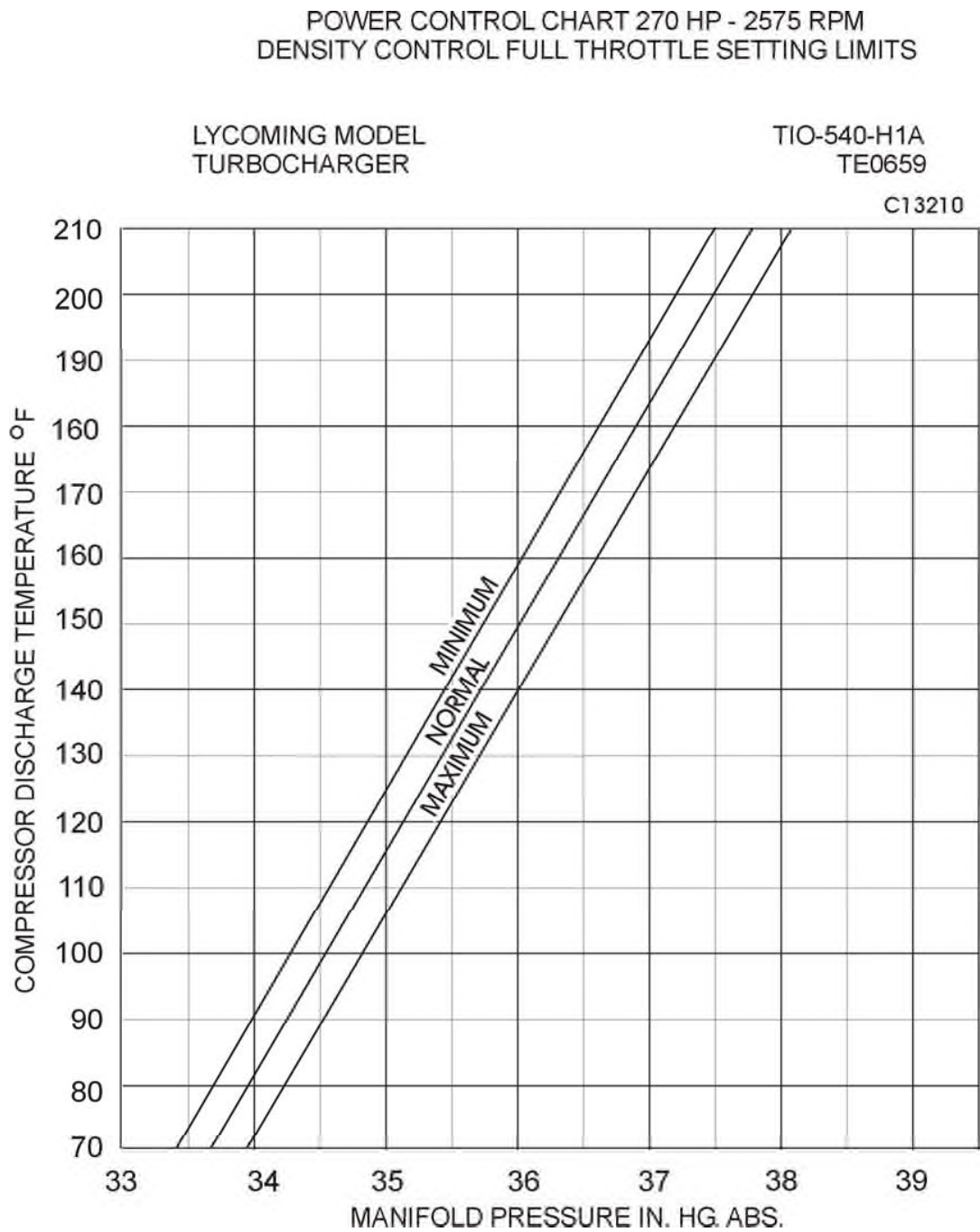

Figure 5-8. Density Control Full Throttle Setting Limits –  
TIO-540-H1A

POWER CONTROL CHART 270 HP, 2575 RPM  
 DENSITY CONTROL FULL THROTTLE SETTING LIMITS  
 ENGINE MODEL TIO-540-AA1AD  
 TURBOCHARGER TE0659

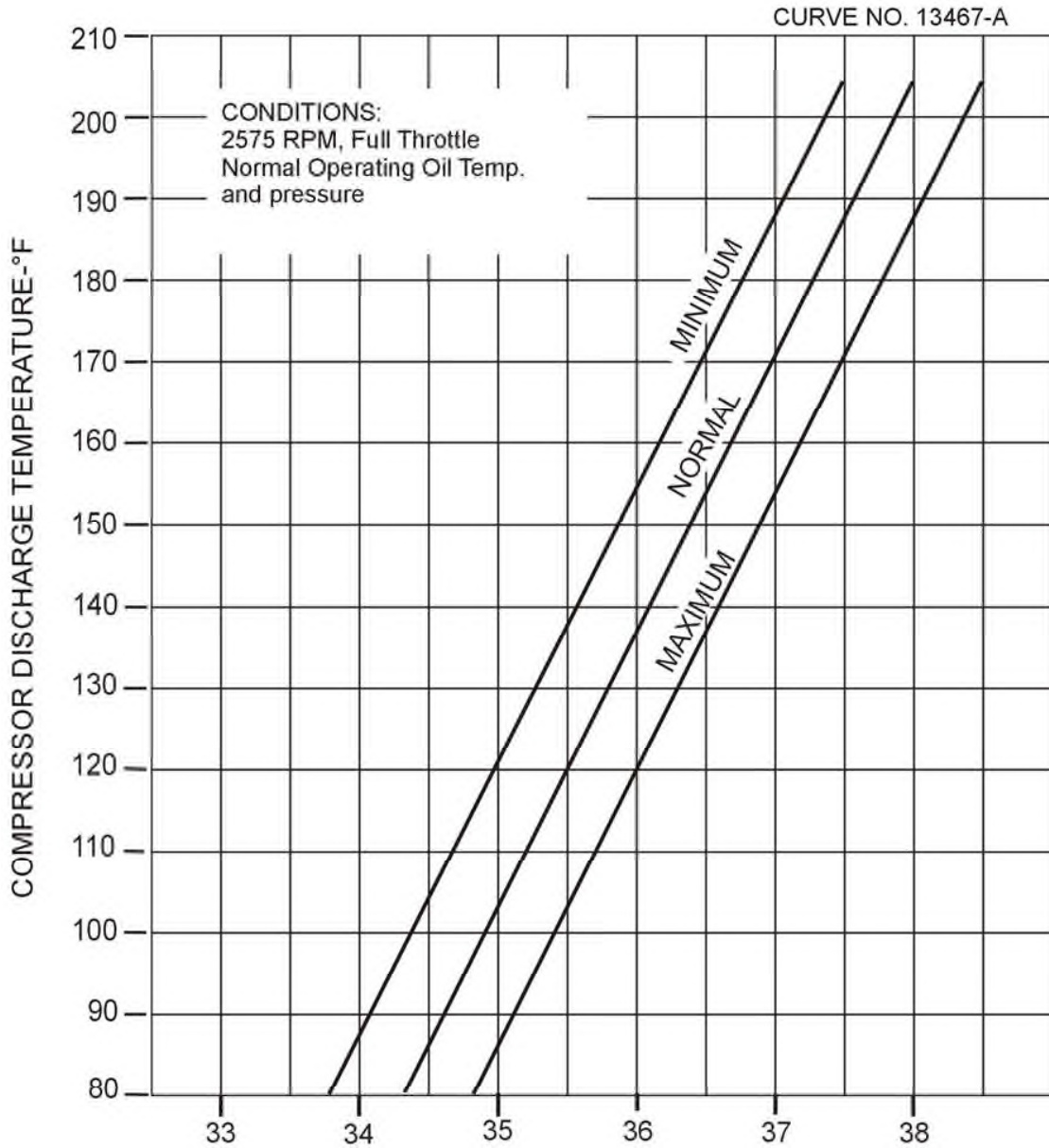

Figure 5-9. Density Control Full Throttle Setting Limits –  
 TIO-540-AA1AD

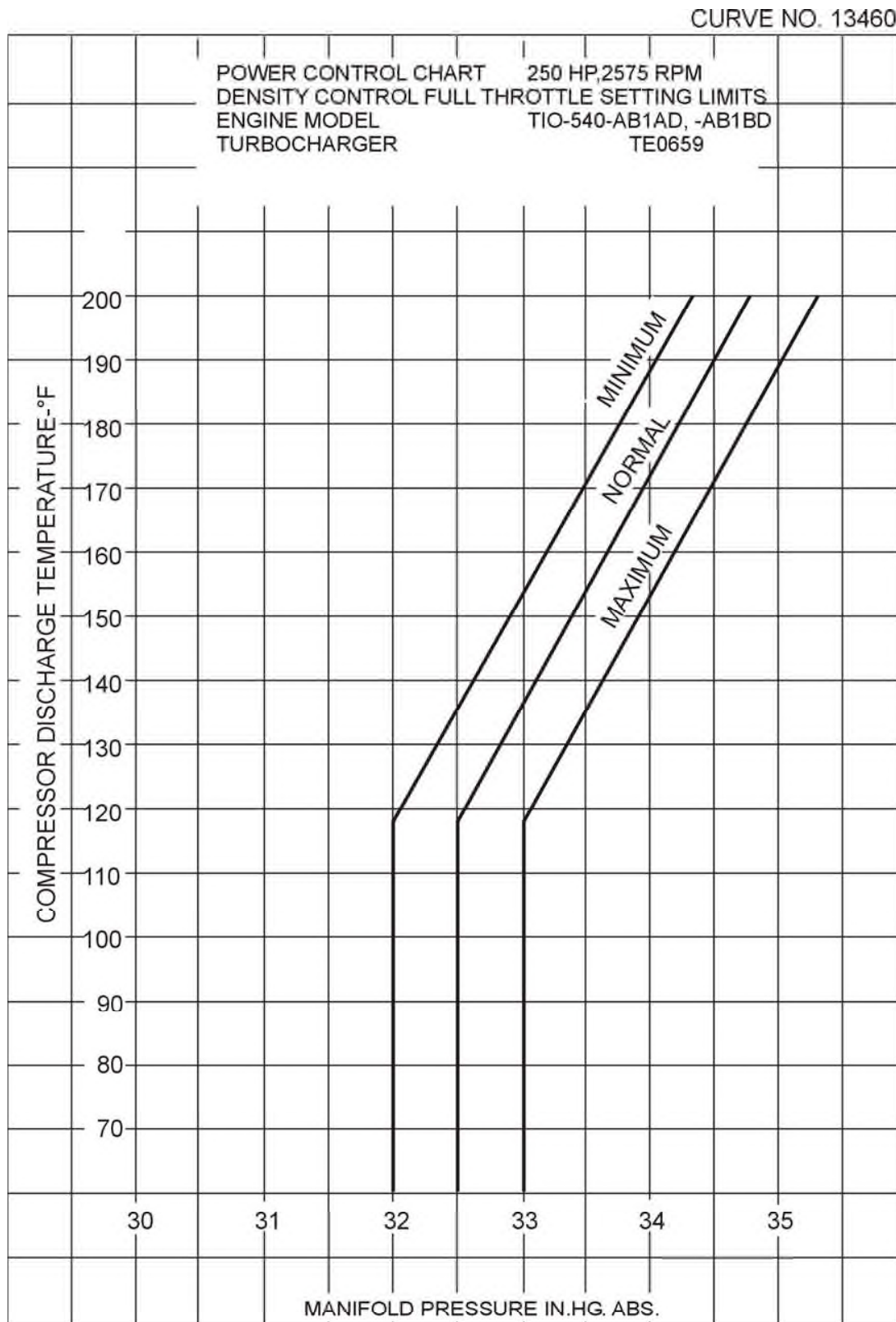

Figure 5-10. Density Control Full Throttle Setting Limits –  
 TIO-540-AB1AD, -AB1BD

CURVE NO. 13495-A

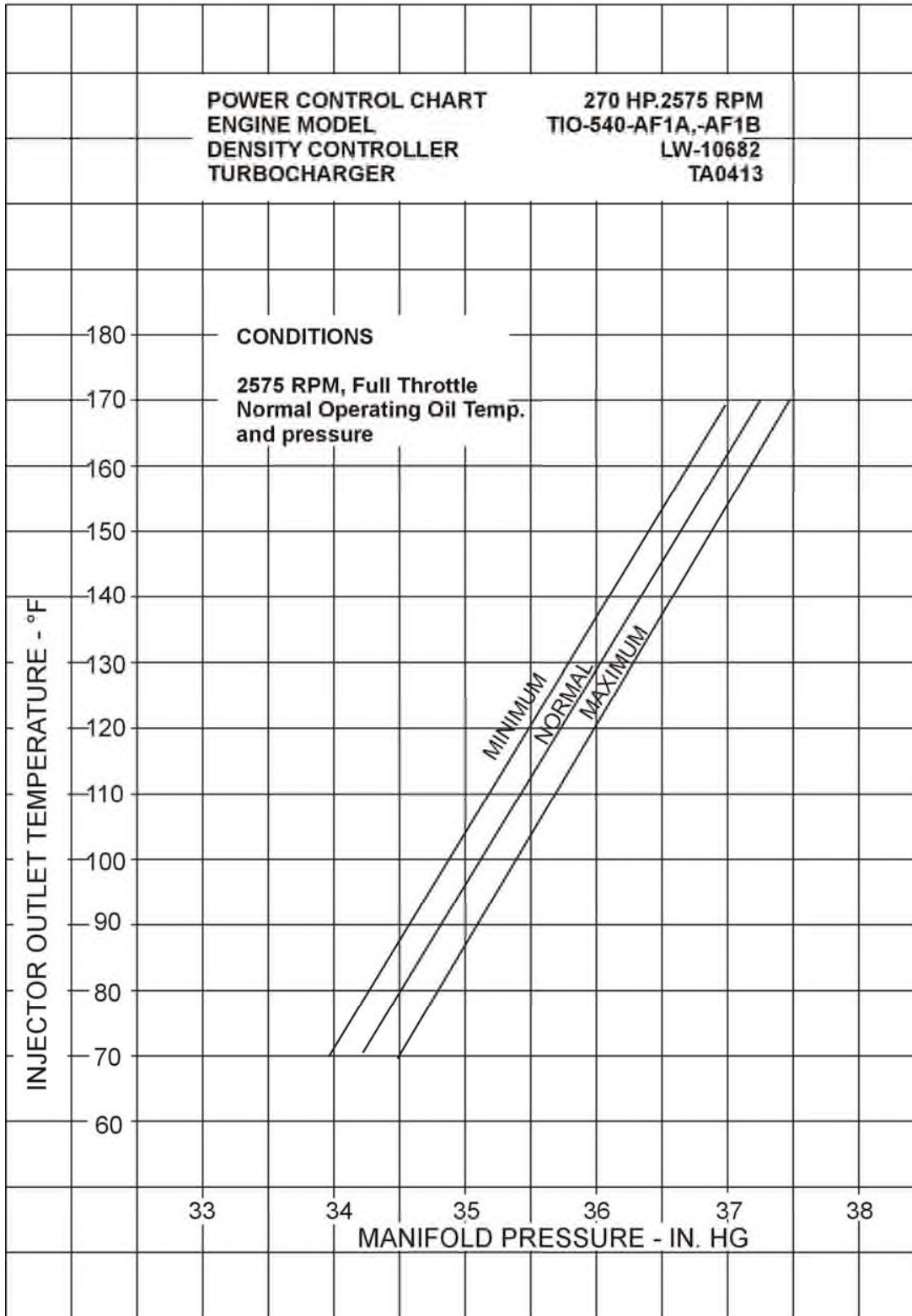

Figure 5-11. Density Control Full Throttle Setting Limits –  
 TIO-540-AF1A, -AF1B

DENSITY CONTROLLER SETTING CURVE  
 TIO-540-AG1A ENGINE  
 270 BPH 2575 RPM, 0.64 BSFC  
 DENSITY CONTROLLERS: LW-10682  
 TURBOCHARGER: TA0413

CURVE NO. 13511

CONDITIONS:

FULL THROTTLE  
 2500 - 2575 RPM  
 NORMAL OIL PRESSURE AND TEMPERATURE

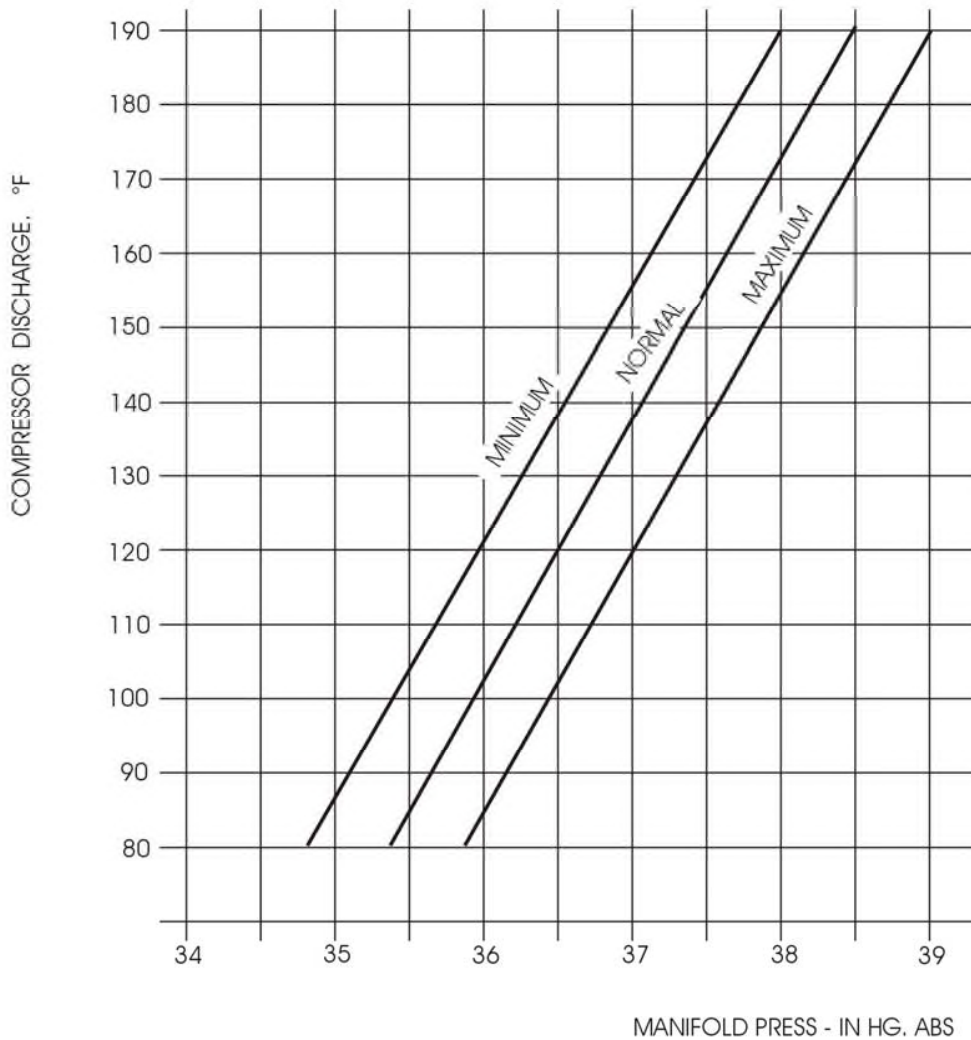

Figure 5-12. Density Control Full Throttle Setting Limits – TIO-540-AG1A

**This Page Intentionally Left Blank**

# LYCOMING OPERATOR'S MANUAL

## SECTION 6 TROUBLE-SHOOTING – ENGINE

	Page
Failure of Engine to Start.....	6-1
Failure of Engine to Idle Properly.....	6-2
Low Power and Uneven Running.....	6-2
Failure of Engine to Develop Full Power .....	6-3
Rough Engine .....	6-3
Low Oil Pressure.....	6-3
High Oil Temperature .....	6-4
Excessive Oil Consumption.....	6-4
High Fuel Flow Indicated on Fuel Gage .....	6-4

## TROUBLE-SHOOTING – TURBOCHARGER

Excessive Noise or Vibration.....	6-5
Engine Will Not Deliver Rated Power .....	6-5
Critical Altitude Lower Than Specified.....	6-6
Engine Surges or Smokes .....	6-6
High Deck Pressure.....	6-6

**This Page Intentionally Left Blank**



SECTION 6

TROUBLE-SHOOTING

Experience has proven that the best method of trouble-shooting is to decide on the various causes of a given trouble and then to eliminate causes one by one, beginning with the most probable. The following charts list some of the more common troubles, which may be encountered in maintaining engines and turbochargers; their probable causes and remedies.

1. TROUBLE-SHOOTING – ENGINE.

TROUBLE	PROBABLE CAUSE	REMEDY
Failure of Engine to Start	Lack of fuel	Check fuel system for leaks. Fill fuel tank. Clean dirty lines, strainers or fuel valves.
	Overpriming	Lean ignition “off” and mixture control in “Idle Cut-Off”, open throttle and “unload” engine by cranking for a few seconds. Turn ignition switch on and proceed to start in a normal manner.
	Defective spark plugs	Clean and adjust or replace spark plugs.
	Defective ignition wire	Check with electric tester, and replace any defective wires.
	Defective battery	Replace with charged battery.
	Improper operation of magneto breaker	Clean points. Check internal timing of magnetos.
	Lack of sufficient fuel flow	Disconnect fuel line and check fuel flow.
	Water in fuel injector or carb.	Drain fuel injector or carburetor and fuel lines.
	Internal failure	Check oil screens for metal particles. If found, complete overhaul of the engine may be indicated.

**SECTION 6  
TROUBLE-SHOOTING**

**LYCOMING OPERATOR'S MANUAL  
TIO-540 SERIES – PARALLEL VALVE CYLINDER HEADS**

TROUBLE	PROBABLE CAUSE	REMEDY
Failure of Engine to Idle Properly	Incorrect idle mixture	Adjust mixture.
	Leak in induction system	Tighten all connections in the induction system. Replace any parts that are defective.
	Incorrect idle adjustment	Adjust throttle stop to obtain correct idle.
	Uneven cylinder compression	Check condition of piston rings and valve seats.
	Faulty ignition system	Check entire ignition system.
	Insufficient fuel pressure	Adjust fuel pressure.
	Leak in air bleed nozzle balance line	Check connection and replace if necessary.
	Plugged fuel injector nozzle	Clean or replace nozzle.
Low Power and Uneven Running	Flow divider fitting plugged	Clean fitting.
	Mixture too rich; indicated by sluggish engine operation, red exhaust flame at night. Extreme cases indicated by black smoke from exhaust.	Readjustment of fuel injector or carburetors by authorized personnel is indicated.
	Mixture too lean; indicated by overheating or backfiring	Check fuel lines for dirt or other restrictions. Readjustment of fuel injector or carburetor by authorized personnel is indicated.
	Leaks in induction system	Tighten all connections. Replace defective parts.
	Defective spark plugs	Clean and gap or replace spark plugs.
	Improper fuel	Fill tank with fuel of recommended grade.
	Magneto breaker points not working properly	Clean points. Check internal timing of magnetos.

TROUBLE	PROBABLE CAUSE	REMEDY
Low Power and Uneven Running (Cont.)	Defective ignition wire	Check wire with electric tester. Replace defective wire.
	Defective spark plug terminal connectors	Replace connectors on spark plug wire.
	Plugged fuel injector nozzle	Clean or replace nozzle.
Failure of Engine to Develop Full Power	Leak in induction system	Tighten all connections and replace defective parts.
	Plugged fuel injector nozzle	Clean or replace nozzle.
	Throttle lever out of adjustment	Adjust throttle lever.
	Improper fuel flow	Check strainer, gage and flow at the fuel line.
	Restriction in air scoop	Examine air scoop and remove restrictions.
	Improper fuel	Drain and refill tank with recommended fuel.
	Faulty ignition	Tighten all connections. Check system with tester. Check ignition timing.
Rough Engine	Cracked engine mount	Replace or repair mounting.
	Defective mounting bushings	Install new mounting bushings.
	Uneven compression	Check compression.
	Plugged fuel injector nozzle	Clean or replace nozzle.
Low Oil Pressure	Insufficient oil	Fill sump to proper level with recommended oil.
	Air lock or dirt in relief valve	Remove and clean oil pressure relief valve.
	Leak in suction line or pressure line	Check gasket between accessory housing and crankcase.

**SECTION 6  
TROUBLE-SHOOTING**

**LYCOMING OPERATOR'S MANUAL  
TIO-540 SERIES – PARALLEL VALVE CYLINDER HEADS**

TROUBLE	PROBABLE CAUSE	REMEDY
Low Oil Pressure (Cont.)	High oil temperature	See “High Oil Temperature” in “Trouble” column.
	Defective pressure gage	Replace.
	Stoppage in oil pump intake passage	Check line for obstruction. Clean suction strainer.
High Oil Temperature	Insufficient oil supply	Fill oil sump to proper level with specified oil.
	Low grade of oil	Replace with oil conforming to specifications.
	Clogged oil lines or strainers	Remove and clean oil strainers.
	Excessive blow-by	Usually caused by worn or stuck rings.
	Failing or failed bearing	Examine sump for metal particles. If found, overhaul of engine is indicated.
Excessive Oil Consumption	Defective temperature gage	Replace gage.
	Low grade of oil	Fill tank with oil conforming to specifications.
	Failing or failed bearings	Check sump for metal particles.
	Worn piston rings	Install new rings.
	Incorrect installation of piston rings	Install new rings.
High Fuel Flow Indication on Fuel Gage	Failure of rings to seat (new nitrided cylinders)	Use mineral base oil. Climb to cruise altitude at full power and operate at 75% cruise power setting until oil consumption stabilizes.
	Plugged fuel injector nozzle	Clean or replace nozzle.

*2. TROUBLE-SHOOTING – TURBOCHARGER.*

TROUBLE	PROBABLE CAUSE	REMEDY
Excessive Noise or Vibration	Improper bearing lubrication	Supply required oil pressure. Clean or replace oil line; clean oil strainer. If trouble persists, overhaul turbocharger.
	Leak in engine intake or exhaust manifold	Tighten loose connections or replace manifold gaskets as necessary.
Engine will not Deliver Rated Power	Dirty impeller blades	Disassemble and clean.
	Clogged manifold system	Clear all ducting.
	Foreign material lodged in compressor impeller or turbine	Disassemble and clean.
	Excessive dirt build-up in compressor	Thoroughly clean compressor assembly. Service air cleaner and check for leakage.
	Leak in engine intake or exhaust	Tighten loose connections or replace manifold gaskets as necessary.
	Rotating assembly bearing seizure	Overhaul turbocharger.
	Restriction in return lines from actuator to exhaust bypass controller	Remove and clean lines.
	Exhaust bypass controller is in need of adjustment	Have exhaust bypass controller adjusted.
	Oil pressure too low	Tighten fittings. Replace lines or hoses, increase oil pressure to desired pressure.
	Inlet orifice to actuator clogged	Remove inlet line at actuator and clean orifice.
Exhaust bypass controller malfunction	Replace unit.	

**SECTION 6  
TROUBLE-SHOOTING**

**LYCOMING OPERATOR'S MANUAL  
TIO-540 SERIES – PARALLEL VALVE CYLINDER HEADS**

TROUBLE	PROBABLE CAUSE	REMEDY
Engine will not Deliver Rated Power (Cont.)	Exhaust bypass butterfly not closing	Low pressure. Clogged orifice in inlet to actuator.  Butterfly shaft binding. Check bearings.
	Turbocharger impeller binding, frozen or fouling housing	Check bearings. Replace turbo-charger.
	Piston seal in actuator leaking. Usually accompanied by oil leakage at drain line	Remove and replace actuator or disassemble and replace packing.
Critical Altitude Lower Than Specified	Controller not getting enough oil pressure to close the exhaust bypass	Check pump outlet pressure, oil filters, external lines for leaks or obstructions.
	Chips under metering valve in controller holding it open	Replace controller.
	Metering jet in actuator plugged	Remove actuator and clean jet.
	Exhaust bypass valve sticking	Clean and free action.
Engine Surges or Smokes	Air in oil lines or actuator	Bleed system.
	Controller metering valve stem seal leaking oil into manifold	Replace controller.
	Clogged breather	Check breather for restrictions to air flow.

*NOTE*

*Smoke would be normal if engine has idled for a prolonged period.*

High Deck Pressure (Compressor Discharge Pressure)	Controller metering valve not opening, aneroid bellow leaking	Replace controller assembly or replace aneroid bellows.
	Exhaust bypass sticking closed	Shut off valve in return lines not working.  Butterfly shaft binding. Check bearings.
		Replace exhaust bypass valve or correct linkage binding.

TROUBLE	PROBABLE CAUSE	REMEDY
High Deck Pressure (Compressor Discharge Pressure) (Cont.)	Controller return line restricted	Clean or replace line.
	Oil pressure too high	Check pressure 75 to 85 psi (80 psi desired) at exhaust bypass actuator inlet.  If pressure on outlet side of actuator is too high, have exhaust bypass controller adjusted.
	Exhaust bypass valve actuator piston locked in full closed position. (Usually accompanied by oil leakage at actuator drain line) NOTE: Exhaust bypass normally closed in idle and low power conditions. Should open when actuator inlet line is disconnected.	Remove and disassemble actuator, check condition of piston and packing or replace actuator assembly.
	Exhaust bypass controller malfunction	Replace controller.

**This Page Intentionally Left Blank**



# LYCOMING OPERATOR'S MANUAL

## SECTION 7 INSTALLATION AND STORAGE

	Page
<b>Preparation of Engine for Installation.....</b>	<b>7-1</b>
<b>General.....</b>	<b>7-1</b>
<b>Inspection of Engine Mounting .....</b>	<b>7-1</b>
<b>Attaching Engine to Mounts .....</b>	<b>7-1</b>
<b>Propeller Installation .....</b>	<b>7-2</b>
<b>Preparation of Fuel Injector for Installation.....</b>	<b>7-2</b>
<b>Corrosion Prevention in Engines Installed in Inactive Aircraft.....</b>	<b>7-2</b>

**This Page Intentionally Left Blank**

## SECTION 7

### INSTALLATION AND STORAGE

*1. PREPARATION OF ENGINE FOR INSTALLATION.* Before installing an engine that has been prepared for storage, remove all dehydrator plugs, bags of desiccant and preservative oil from the engine. Preservation oil can be removed by removing the bottom spark plugs and turning the crankshaft three or four revolutions by hand. The preservative oil will then drain through the spark plug holes. Draining will be facilitated if the engine is tilted from side to side during the above operation. Preservative oil which has accumulated in the sump can be drained by removing the oil sump plug. Engines that have been stored in a cold place should be removed to an environment of at least 70°F (21°C) for a period of 24 hours before preservative oil is drained from the cylinders. If this is not possible, heat the cylinders with heat lamps before attempting to drain the engine.

After the oil sump has been drained, the plug should be replaced, safety-wired, and the sump refilled with lubricating oil. The crankshaft should again be turned several revolutions to saturate the interior of the engine with the clean oil. When installing spark plugs, make sure that they are clean, if not, wash them in clean petroleum solvent. Of course, there will be a small amount of preservative oil remaining in the engine, but this can cause no harm. However, after twenty-five hours of operation, the lubricating oil should be drained while the engine is hot. This will remove any residual preservative oil that may have been present.

#### CAUTION

*DO NOT ROTATE THE CRANKSHAFT OF AN ENGINE CONTAINING PRESERVATIVE OIL BEFORE REMOVING THE SPARK PLUGS, BECAUSE IF THE CYLINDERS CONTAIN ANY APPRECIABLE AMOUNT OF THE MIXTURE, THE RESULTING ACTION, KNOWN AS HYDRAULICING, WILL CAUSE DAMAGE TO THE ENGINE. ALSO, ANY CONTACT OF THE PRESERVATIVE OIL WITH PAINTED SURFACES SHOULD BE AVOIDED.*

*General* – Should any of the dehydrator plugs, containing crystals of silica-gel or similar material, be broken during their term of storage or upon their removal from the engine, and if any of the contents should fall into the engine, that portion of the engine must be disassembled and thoroughly cleaned before using the engine. The oil strainers should be removed and cleaned in gasoline or some other hydrocarbon solvent. The fuel drain screen located in the fuel inlet of the carburetor or fuel injector should also be removed and cleaned in a hydrocarbon solvent. The operator should also note if any valves are sticking. If they are, this condition can be eliminated by coating the valve stem generously with a mixture of gasoline and lubrication oil.

*Inspection of Engine Mounting* – If the aircraft is one from which an engine has been removed, make sure that the engine mount is not bent or damaged by distortion or misalignment as this can produce abnormal stresses within the engine.

*Attaching Engine to Mounts* – See airframe manufacturer's recommendations for method of mounting the engine.

*Oil and Fuel Line Connections* – The oil and fuel line connections are called out on the accompanying installation drawings.

*Propeller Installation* – Consult the airframe manufacturer for information relative to propeller installation.

## 2. PREPARATION OF FUEL INJECTORS FOR INSTALLATION.

Fuel injectors that have been prepared for storage should undergo the following procedures before being placed in service.

*Fuel Injector (Bendix or PAC)* – Remove and clean the fuel inlet strainer assembly and reinstall. Inject clean fuel into the fuel inlet connection with the fuel outlets uncapped until clean fuel flows from the outlets. Do not exceed 15 psi inlet pressure.

### *CORROSION PREVENTION IN ENGINES INSTALLED IN INACTIVE AIRCRAFT*

Corrosion can occur, especially in new or newly overhauled engines, on cylinder walls of engines that will be inoperative for periods as brief as two days. Therefore, the following preservation procedure is recommended for inactive engines and will be effective in minimizing the corrosion condition for a period of up to thirty days.

#### *NOTE*

*Ground running the engine for brief periods of time is not a substitute for the following procedure; in fact, the practice of ground running will tend to aggravate rather than minimize this corrosion condition.*

- a. As soon as possible after the engine is stopped, move the aircraft into the hangar, or other shelter where the preservation process is to be performed.
- b. Remove sufficient cowling to gain access to the spark plugs and remove both spark plugs from each cylinder.
- c. Spray the interior of each cylinder with approximately two (2) ounces of corrosion preventive oil while cranking the engine about five (5) revolutions with the starter. The spray gun nozzle may be placed in either of the spark plug holes.

#### *NOTE*

*Spraying should be accomplished using an airless spray gun (Spraying Systems Co., "Gunjet" Model 24A-8395 or equivalent). In the event an airless spray gun is not available, personnel should install a moisture trap in the air line of a conventional spray gun and be certain oil is hot at the nozzle before spraying cylinders.*

- d. With the crankshaft stationary, again spray each cylinder through the spark plug holes with approximately two ounces of corrosion preventive oil. Assemble spark plugs and do not turn crankshaft after cylinders have been sprayed.

The corrosion preventive oil to be used in the foregoing procedure should conform to specification MIL-L-6529, Type 1 heated to 200°F/220°F (93°C/104°C) spray nozzle temperature. It is not necessary to flush preservative oil from the cylinder prior to flying the aircraft. The small quantity of oil coating the cylinders will be expelled from the engine during the first few minutes of operation.

*NOTE*

*Oils of the type mentioned are to be used in Lycoming aircraft engines for corrosion prevention only, and not for lubrication. See the latest revisions of Lycoming Service Instruction No. 1014 and Service Bulletin No. 318 for recommended lubricating oil.*

**This Page Intentionally Left Blank**

# LYCOMING OPERATOR'S MANUAL

## SECTION 8 TABLES

	Page
Table of Limits .....	8-1
Ground Run After Top Overhaul .....	8-2
Flight Test After Top Overhaul.....	8-3
Full Throttle HP at Altitude.....	8-4
Table of Speed Equivalents .....	8-4
Centigrade – Fahrenheit Conversion.....	8-5
Inch – Fraction Conversion .....	8-6

**This Page Intentionally Left Blank**



**SECTION 8**

**TABLES**

FOR TIGHTENING TORQUE RECOMMENDATIONS AND INFORMATION CONCERNING TOLERANCES AND DIMENSIONS THAT MUST BE MAINTAINED IN LYCOMING AIRCRAFT ENGINES, CONSULT LATEST REVISION OF SPECIAL SERVICE PUBLICATION NO. SSP-1776.

CONSULT LATEST REVISION OF SERVICE INSTRUCTIONS NO. 1029 AND NO. 1150 FOR INFORMATION PERTINENT TO CORRECTLY INSTALLING CYLINDER ASSEMBLY.

**FIXED WING ONLY**

**GROUND RUN AFTER TOP OVERHAUL  
OR CYLINDER CHANGE WITH NEW RINGS  
(DO NOT USE AFTER MAJOR OVERHAUL)**

1. Avoid dusty location and loose stones.
2. Head aircraft into the wind.
3. All cowlings should be in place, cowl flaps open.
4. Accomplish ground run in full flat pitch.
5. Never exceed 200°F. oil temperature.
6. If cylinder head temperatures reach 400°F., shut down and allow engine to cool before continuing.

Type Aircraft \_\_\_\_\_  
 Registration No. \_\_\_\_\_  
 Aircraft No. \_\_\_\_\_  
 Owner \_\_\_\_\_  
 Engine Model \_\_\_\_\_ S/N \_\_\_\_\_  
 Date \_\_\_\_\_  
 Run-Up By \_\_\_\_\_

**GROUND RUN**

Time	RPM	MAP	Temperature			Pressure			Temperature			Fuel Flow				
			L. oil	R. oil	L. cyl.	R. cyl.	L. oil	R. oil	L. fuel	R. fuel	L. carb.	R. carb.	Amb. Air	Left	Right	
5 min	1000															
10 min	1200															
10 min	1300															
5 min	1500															
5 min	1600															
5 min	1700															
5 min	1800															

Mag. Check \_\_\_\_\_ Adjustment Required \_\_\_\_\_ After Completion of Ground Run \_\_\_\_\_  
 Power Check \_\_\_\_\_ 1. Visually inspect engine(s)  
 Idle Check \_\_\_\_\_ 2. Check oil levels

**FLIGHT TEST AFTER TOP OVERHAUL  
 OR CYLINDER CHANGE WITH NEW RINGS**

1. Test fly aircraft one hour.
2. Use standard power for climb, and at least 75% power for cruise.
3. Make climb shallow and at good airspeed for cooling.
4. Record engine instrument readings during climb and cruise.

Tested by \_\_\_\_\_

**FLIGHT TEST RECORD**

Time (Climb) Cruise	RPM	MAP	Temperature		Pressure		Temperature		Fuel Flow												
			L. oil	R. oil	L. cyl.	R. cyl.	L. oil	R. oil	L. fuel	R. fuel	L. carb	R. carb	Amb. Air	Left	Right						

Adjustment Required After Flight

After Test Flight.

1. Make careful visual inspection of engine(s).
2. Check oil level(s).
3. If oil consumption is excessive, (see operator's manual for limits), remove spark plugs and check cylinder barrels for scoring.

**SECTION 8  
TABLES**

**LYCOMING OPERATOR'S MANUAL  
TIO-540 SERIES – PARALLEL VALVE CYLINDER HEADS**

**FULL THROTTLE HP AT ALTITUDE  
(Normally Aspirated Engines)**

Altitude Ft.	% S.L. H.P.	Altitude Ft.	% S.L. H.P.	Altitude Ft.	% S.L. H.P.
0	100	10,000	70.8	19,500	49.1
500	98.5	11,000	68.3	20,000	48.0
1,000	96.8	12,000	65.8	20,500	47.6
2,000	93.6	13,000	63.4	21,000	46.0
2,500	92.0	14,000	61.0	21,500	45.2
3,000	90.5	15,000	58.7	22,000	44.0
4,000	87.5	16,000	56.5	22,500	43.3
5,000	84.6	17,000	54.3	23,000	42.2
6,000	81.7	17,500	53.1	23,500	41.4
7,000	78.9	18,000	52.1	24,000	40.3
8,000	76.2	18,500	51.4	24,500	39.5
9,000	73.5	19,000	50.0	25,000	38.5

**TABLE OF SPEED EQUIVALENTS**

Sec./Mi.	M.P.H.	Sec./Mi.	M.P.H.	Sec./Mi.	M.P.H.
72.0	50	24.0	150	14.4	250
60.0	60	22.5	160	13.8	260
51.4	70	21.2	170	13.3	270
45.0	80	20.0	180	12.8	280
40.0	90	18.9	190	12.4	290
36.0	100	18.0	200	12.0	300
32.7	110	17.1	210	11.6	310
30.0	120	16.4	220	11.2	320
27.7	130	15.6	230	10.9	330
25.7	140	15.0	240	10.6	340

**CENTIGRADE-FAHRENHEIT CONVERSION TABLE**

Example: To convert 20°C to Fahrenheit, find 20 in the center column headed (F-C); then read 68.0°F in the column (F) to the right. To convert 20°F to Centigrade; find 20 in the center column and read -6.67°C in the (C) column to the left.

C	F-C	F	C	F-C	F
-56.7	-70	-94.0	104.44	220	428.0
-51.1	-60	-76.0	110.00	230	446.0
-45.6	-50	-58.0	115.56	240	464.0
-40.0	-40	-40.0	121.11	250	482.0
-34.4	-30	-22.0	126.67	260	500.0
-28.9	-20	-4.0	132.22	270	518.0
-23.3	-10	14.0	137.78	280	536.0
-17.8	0	32.0	143.33	290	554.0
-12.22	10	50.0	148.89	300	572.0
-6.67	20	68.0	154.44	310	590.0
-1.11	30	86.0	160.00	320	608.0
4.44	40	104.0	165.56	330	626.0
10.00	50	122.0	171.11	340	644.0
15.56	60	140.0	176.67	350	662.0
21.11	70	158.0	182.22	360	680.0
26.67	80	176.0	187.78	370	698.0
32.22	90	194.0	193.33	380	716.0
37.78	100	212.0	198.89	390	734.0
43.33	110	230.0	204.44	400	752.0
48.89	120	248.0	210.00	410	770.0
54.44	130	266.0	215.56	420	788.0
60.00	140	284.0	221.11	430	806.0
65.56	150	302.0	226.67	440	824.0
71.00	160	320.0	232.22	450	842.0
76.67	170	338.0	237.78	460	860.0
82.22	180	356.0	243.33	470	878.0
87.78	190	374.0	248.89	480	896.0
93.33	200	392.0	254.44	490	914.0
98.89	210	410.0	260.00	500	932.0

**INCH FRACTIONS CONVERSIONS  
Decimals, Area of Circles and Millimeters**

Inch Fraction	Decimal Equiv.	Area Sq. In.	MM Equiv.	Inch Fraction	Decimal Equiv.	Area Sq. In.	MM Equiv.
1/64	.0156	.0002	.397	1/2	.5	.1964	12.700
1/32	.0312	.0008	.794	17/32	.5312	.2217	13.494
3/54	.0469	.0017	1.191	35/64	.5469	.2349	13.891
1/16	.0625	.0031	1.587	9/61	.5625	.2485	14.288
3/32	.0937	.0069	2.381	19/32	.5937	.2769	15.081
7/64	.1094	.0094	2.778	39/64	.6094	.2916	15.478
1/8	.125	.0123	3.175	5/8	.625	.3068	15.875
5/32	.1562	.0192	3.969	21/32	.6562	.3382	16.669
11/64	.1719	.0232	4.366	43/64	.6719	.3545	17.065
3/16	.1875	.0276	4.762	11/16	.6875	.3712	17.462
7/32	.2187	.0376	5.556	23/32	.7187	.4057	18.256
15/64	.2344	.0431	5.593	47/64	.7344	.4235	18.653
1/4	.25	.0491	6.530	3/4	.75	.4418	19.050
9/32	.2812	.0621	7.144	25/32	.7812	.4794	19.844
19/64	.2969	.0692	7.540	51/64	.7969	.4986	20.241
5/16	.3125	.0767	7.937	13/16	.8125	.5185	20.637
11/32	.3437	.0928	8.731	27/32	.8437	.5591	21.431
23/64	.3594	.1014	9.128	55/64	.8594	.5800	21.828
3/8	.375	.1105	9.525	7/8	.875	.6013	22.225
13/32	.4062	.1296	10.319	29/32	.9062	.6450	23.019
27/64	.4219	.1398	10.716	59/64	.9219	.6675	23.416
7/16	.4375	.1503	11.112	15/16	.9375	.6903	23.812
15/32	.4687	.1725	11.906	31/32	.9687	.7371	24.606
31/64	.4844	.1842	12.303	63/64	.9844	.7610	25.003